

DA-682A-DPP Hardware User's Manual

Edition 1.0, March 2016

www.moxa.com/product

MOXA[®]

© 2016 Moxa Inc. All rights reserved.

DA-682A-DPP Hardware User's Manual

The software described in this manual is furnished under a license agreement and may be used only in accordance with the terms of that agreement.

Copyright Notice

© 2016 Moxa Inc. All rights reserved.

Trademarks

The MOXA logo is a registered trademark of Moxa Inc.
All other trademarks or registered marks in this manual belong to their respective manufacturers.

Disclaimer

Information in this document is subject to change without notice and does not represent a commitment on the part of Moxa.

Moxa provides this document as is, without warranty of any kind, either expressed or implied, including, but not limited to, its particular purpose. Moxa reserves the right to make improvements and/or changes to this manual, or to the products and/or the programs described in this manual, at any time.

Information provided in this manual is intended to be accurate and reliable. However, Moxa assumes no responsibility for its use, or for any infringements on the rights of third parties that may result from its use.

This product might include unintentional technical or typographical errors. Changes are periodically made to the information herein to correct such errors, and these changes are incorporated into new editions of the publication.

Technical Support Contact Information

www.moxa.com/support

Moxa Americas

Toll-free: 1-888-669-2872
Tel: +1-714-528-6777
Fax: +1-714-528-6778

Moxa Europe

Tel: +49-89-3 70 03 99-0
Fax: +49-89-3 70 03 99-99

Moxa India

Tel: +91-80-4172-9088
Fax: +91-80-4132-1045

Moxa China (Shanghai office)

Toll-free: 800-820-5036
Tel: +86-21-5258-9955
Fax: +86-21-5258-5505

Moxa Asia-Pacific

Tel: +886-2-8919-1230
Fax: +886-2-8919-1231

Table of Contents

1. Introduction	1
Overview	2
Model Descriptions and Package Checklist	2
Appearance	3
Dimensions	4
Features	4
Hardware Block Diagram	5
DA-682A-DPP Basic System	5
Hardware Specifications	5
Basic Systems	5
Expansion Modules	7
Software-Selectable Serial Ports	7
Time Synchronization and DI/DO Ports	7
Ethernet Switching Port	7
Universal PCI Slot	7
2. Hardware Installation	1
Placement Options	2
Desk	2
Rack Mounting	2
Wiring Requirements	4
Connecting the Power	5
Wiring the Power Inputs	5
Reset Button	6
Front Panel LED	6
Connecting to a Display	7
Connecting USB Devices	8
Gigabit LAN Ports	8
Upgrading the Memory Module	9
Installing a CompactFlash Card	10
Installing a Disk on Module (DOM)	11
Installing SATA Hard Disks	12
Installing and Removing Expansion Modules	15
DA-SP08-I-DB/DA-SP08-DB/DA-SP08-I-EMC4-DB Serial Expansion Modules	16
DA-SP08-I-TB/DA-SP08-I-EMC4-TB Serial Expansion Modules	16
DA-IRIGB-4DIO-PCI104-EMC4 Module	17
DA-IRIGB-4DIO-PCI104-EMC4 Pin Assignments	17
Connecting a DA-IRIGB-B-S Module	18
3. BIOS Setup	1
Entering the BIOS Setup	2
Main Information	3
Advanced Settings	3
Boot Configuration	4
HDC Configuration	4
Video Configuration	5
Chipset Configuration	6
Hardware Monitor	7
Smart Recovery Info	7
Security Settings	7
Set Supervisor Password	8
Power Settings	8
Turbo Mode	8
Auto Wake on S5	8
Wake on LAN	9
Boot Settings	9
Boot Type	9
PXE Boot to LAN	9
Add Boot Options	9
USB Boot	10
EFI Device First	10
Boot Delay Time	10
Legacy	10
Exit Settings	10
Exit Saving Changes	11
Save Change Without Exit	11
Exit Discarding Changes	11
Load Optimal Defaults	11
Load Custom Defaults	11
Save Custom Defaults	11

Discard Changes	11
Upgrading the BIOS	12
A. Safety Installation Instructions	1

Introduction

Thank you for purchasing a Moxa DA-682A-DPP Series ready-to-run industrial computer.

This manual introduces you to the hardware installation, connector interfaces, and BIOS setup of the DA-682A-DPP. For software configuration and management, please refer to the user's manual for the operating system installed on the computer.

The following topics are covered in this chapter:

- ❑ **Overview**
- ❑ **Model Descriptions and Package Checklist**
- ❑ **Appearance**
- ❑ **Dimensions**
- ❑ **Features**
- ❑ **Hardware Block Diagram**
 - DA-682A-DPP Basic System
- ❑ **Hardware Specifications**
 - Basic Systems
- ❑ **Expansion Modules**
 - Software-Selectable Serial Ports
 - Time Synchronization and DI/DO Ports
 - Ethernet Switching Port
 - Universal PCI Slot

Overview

The DA-682A-DPP computers have an x86 platform with VGA, 6 gigabit Ethernet ports, CompactFlash, USB, and two PCI ports that you can use for DA Series expansion modules. The DA-682A-DPP comes with three different CPU options and basic models that allow system designers to install the DOM, RAM, and operating system according to their specific requirements.

IEC-61850-3 and IEEE 1613 compliance confirms that the DA-682A-DPP can deliver stable and reliable system operations in power applications. Additional value and convenience is provided through a modular design with two independent slots for flexible system integration and expansion. Users have the option to add a variety of different communications modules, including an 8-port RS-232/422/485 module, 8-port RS-422/485 module, 8-port 10/100 Mbps switch module, IRIG-B time synchronization card, and a universal PCI expansion module.

The DA-682A-DPP also complies with the IEC 60255 standards to enable the protection of electrical relays in a smart substation. IEC 60255 is one of the most widely used standards for testing relays and protection equipment, and compliance with the standard ensures that the DA-682A-DPP will work reliably and seamlessly with IEDs (intelligent electronic devices) as a part of a robust substation automation system.

Smart Recovery Function

The Moxa Smart Recovery™ function on the DA-682A-DPP makes it easy to fix operating system problems to minimize downtime. Moxa Smart Recovery is an automated BIOS-level software recovery system that allows engineers to (1) automatically recover an OS system after a crash, and (2) set up manual recovery processes to fix OS-related problems.

Proactive Monitoring Function

The DA-682A-DPP's Proactive Monitoring function monitors the computer's health by keeping an eye on the CPU usage, memory usage, storage partition usage, the operating temperature of the CPU and motherboard, and can trigger a relay to provide either visual or audio alarms.

Model Descriptions and Package Checklist

The DA-682A-DPP Series includes the following models:

- **DA-682A-C1-DPP:** Rackmount computer with Celeron 1047UE, 1.4 GHz, dual-core CPU, without DOM/RAM/OS; VGA, 6 Gigabit LANs, USB x 4, Compact Flash socket
- **DA-682A-C1-DPP-LX:** Rackmount computer with Celeron 1047UE, 1.4 GHz, dual-core CPU, VGA, 6 Gigabit LANs, USB x 4, Compact Flash socket, 1 GB system memory, 2 GB DOM, Linux Debian 7 pre-installed flash disk module
- **DA-682A-C3-DPP:** Rackmount computer with Core i3-3217UE, 1.6 GHz, dual-core CPU, without DOM/RAM/OS; VGA, 6 Gigabit LANs, USB x 4, Compact Flash socket
- **DA-682A-C3-DPP-LX:** Rackmount computer with Core i3-3217UE, 1.6 GHz, dual-core CPU, VGA, 6 Gigabit LANs, USB x 4, Compact Flash socket, 1 GB system memory, 2 GB DOM, Linux Debian 7 pre-installed flash disk module
- **DA-682A-C7-DPP:** Rackmount computer with Core i7-3517UE, 1.7 GHz, dual-core CPU, without DOM/RAM/OS; VGA, 6 Gigabit LANs, USB x 4, Compact Flash socket
- **DA-682A-C7-DPP-LX:** Rackmount computer with Core i7-3517UE, 1.7 GHz, dual-core CPU, VGA, 6 Gigabit LANs, USB x 4, Compact Flash socket, 1 GB system memory, 2 GB DOM, Linux Debian 7 pre-installed flash disk module

Each model ships with following additional items:

- Rackmount kit
- Quick Installation Guide & Documentation CD
- Product Warranty Statement

Optional Expansion Modules:

- **DA-SP08-I-EMC4-DB:** 8-port RS-232/422/485 serial module with a digitally isolated DB9 connector; suitable for EMC Level 4 environments
- **DA-SP08-I-EMC4-TB:** 8-port RS-232/422/485 serial module with a digitally isolated terminal block connector; suitable for EMC Level 4 environments
- **DA-SP08-I-DB:** 8-port RS-232/422/485 serial module with a digitally isolated DB9 connector
- **DA-SP08-DB:** 8-port RS-232/422/485 serial module with a DB9 connector
- **DA-SP08-I-TB:** 8-port RS-422/485 serial module with a digitally isolated terminal block
- **DA-SP38-I-TB:** 8-port RS-422/485 serial module with a digitally isolated terminal block
- **DA-SW08-RJ:** 8-port 10/100 Mbps unmanaged switch module
- **DA-UPCI-DK:** Universal PCI development kit
- **DA-FX04-MM-ST-T:** 4-port (100BaseFX) fiber LAN module with a multi-mode ST connector that supports IP Teaming
- **DA-IRIGB-4DIO-PCI104-EMC4:** Time synchronization expansion module, 1 IRIG-B signal input port, 3 digital inputs, 4 digital outputs (DA-681A-I-DPP series only)



ATTENTION

Additional expansion modules are currently under development.

Appearance

Front View

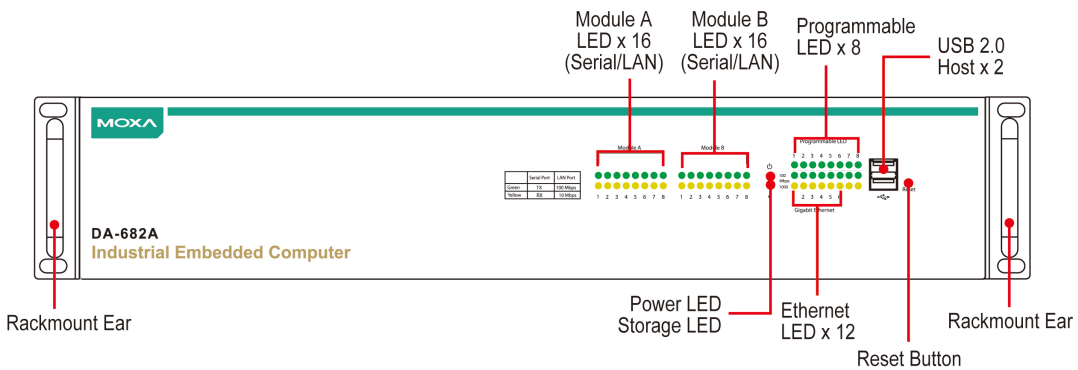

Rear View

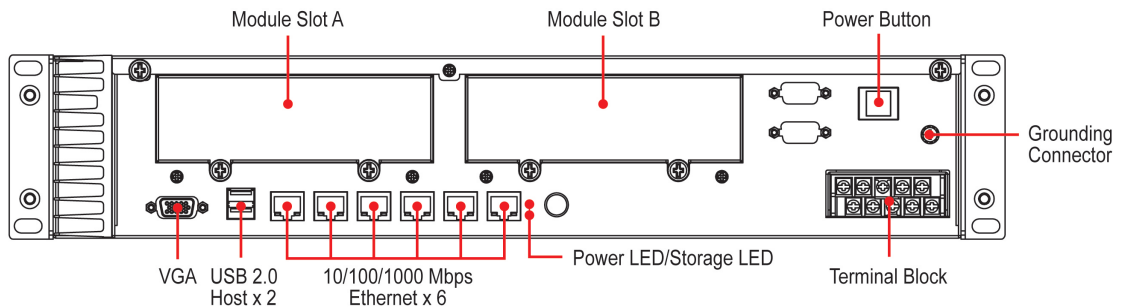

Dimensions

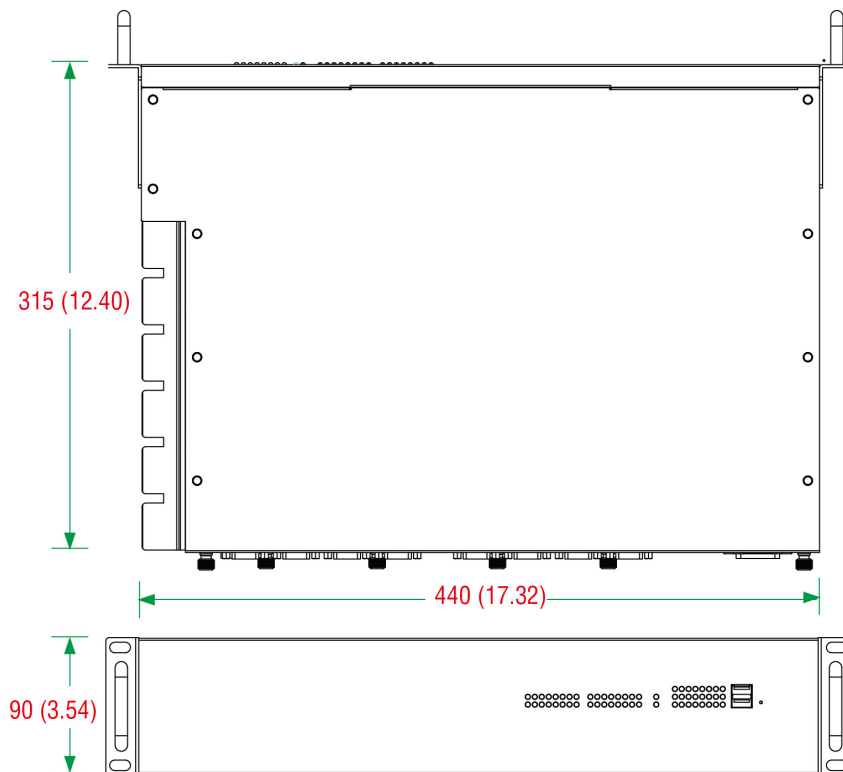

Features

The DA-682A-DPP computer has the following features:

- IEC 61850-3, IEEE 1613, and IEC 60255 compliant for power substation automation systems
- 3rd generation Intel core processors (Ivy Bridge)
- Built-in DDR3 SDRAM and industrial DOM
- 6-gigabit Ethernet ports for network redundancy
- 2 PCI expansion slots for expansion modules
- 1 CompactFlash socket for storage expansion
- 4 high-speed system-bootable USB 2.0 ports
- Supports both 100 to 240 VAC and VDC power inputs (dual power)
- Optional IRIG-B expansion module for time synchronization.
- 8 or 16 software selectable RS-232/422/485 serial ports, with or without isolation protection

Hardware Block Diagram

DA-682A-DPP Basic System

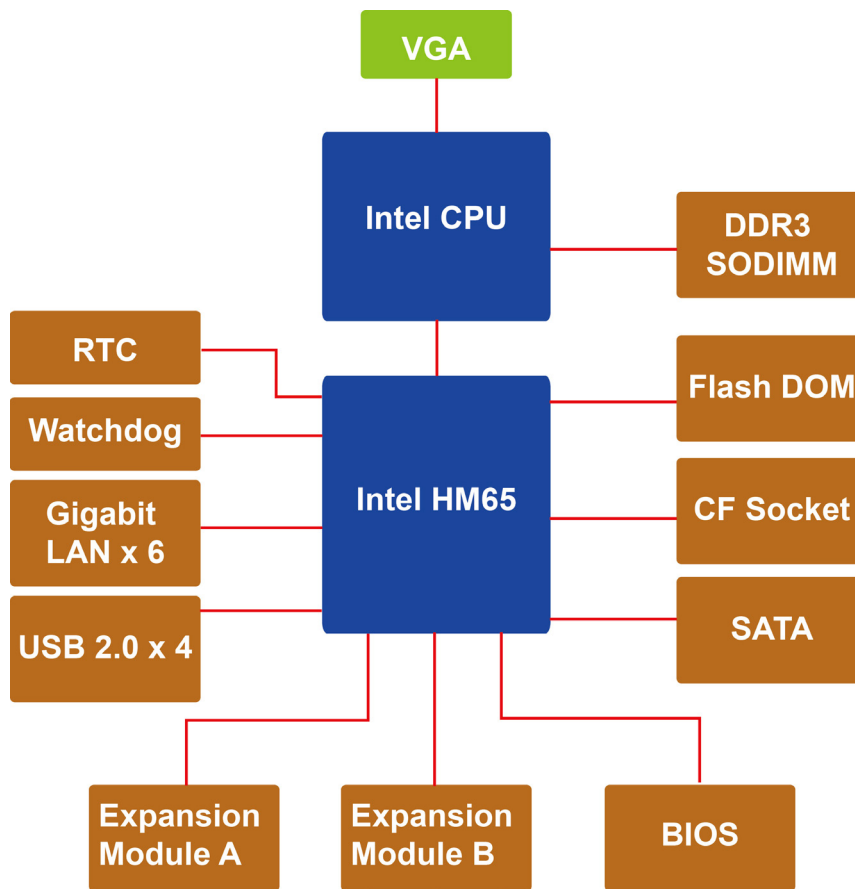

Hardware Specifications

Basic Systems

Computer

CPU: 3rd generation Intel core processors (Ivy Bridge)

- Intel Celeron 1047UE, 1.4 GHz dual-core processor
- Intel Core i3-3217UE, 1.6 GHz dual-core processor
- Intel Core i7-3517UE, 1.7 GHz dual-core processor

OS (pre-installed): Linux Debian 8 (pre-installed)

Note: W7E available by CTOS

System Chipset: Intel HM65

BIOS: SPI Flash 64-Mbit BIOS, PCI Plug & Play, ACPI function support

System Memory: 8 GB capacity, 1 GB for Linux pre-installed; 1 slot of DDR3-1066/1333 SO-DIMM SDRAM

USB: USB 2.0 hosts x 2, system bootable, type A connector

Storage

Built-in: 2 GB for Linux (pre-installed industrial DOM)

Storage Expansion:

- 1 x CompactFlash socket
- 2 x SATA-300 connector

Display

Graphics Controller: Intel® HD Graphics (Integrated)

Display Interface: 1 VGA output (DB15 female connector)

Resolution: CRT display mode with pixel resolution up to 2048 x 1536 at 75 Hz

Ethernet Interface

LAN: Auto-sensing 10/100/1000 Mbps Gigabit ports x 6

Magnetic Isolation Protection: 1.5 kV built-in

LEDs

System: Power, Storage

LAN: 100/1000M mode

Programmable: 8 LEDs

Communication: Module A x 16, Module B x 16

Switches and Buttons

Power Button: On/Off (on rear panel)

Reset Button: Hard Reset (on front panel)

Physical Characteristics

Housing: SECC sheet metal (1 mm)

Weight: 6.5 kg (14.33 lb)

Dimensions: 440 x 315 x 90 mm (17.32 x 12.40 x 3.54 in) (without rackmount ears)

Mounting: Standard 19-inch rack

Environmental Limits

Operating Temperature: -25 to 60°C (-13 to 140°F)

Storage Temperature: -40 to 80°C (-40 to 176°F)

Ambient Relative Humidity: 5 to 95% (non-condensing)

Anti-vibration: 7 mm (2-9 Hz), 20 m/s/s (9-200 Hz), 15 m/s/s (200-500 Hz) @ IEC-61850-3, IEC 60870-2-2/Cm/(3M6)/(4M6), sine wave, 2-500 Hz, 1 Oct/min, 10 cycles, 2 hrs 40 mins per axis

Anti-shock: 300 m/s/s @ IEC-61850-3, IEC 60870-2-2/Cm/(3M6)/(4M6), half sine wave, 11 ms

Power Requirements

Input Voltage: 100 to 240 VAC; 100 to 240 VDC

Input Current: 1.37 A @ 100 VAC; 0.77 A @ 100 VDC

Standards and Certifications

Safety: UL 60950-1, IEC 60950-1, EN 60950-1

Electrical Substation: IEC 61850-3, IEEE 1613, IEC 60255

Protection Relay: IEC 60255

EMC: EN 61000-6-2/6-4

EMI: CISPR 22, FCC Part 15B Class A

EMS:

IEC 61000-4-2 ESD: Contact: 8 kV; Air: 15 kV

IEC 61000-4-3 RS: 80 MHz to 1 GHz: 10 V/m

IEC 61000-4-4 EFT: Power: 4 kV; Signal: 4 kV

IEC 61000-4-5 Surge: Power: 4 kV; Signal: 4 kV

IEC 61000-4-6 CS: 10 V

IEC 61000-4-8

IEC 61000-4-11

Reliability

Alert Tools:

- Built-in buzzer and RTC (real-time clock) with lithium battery backup
- Built-in 1 relay for audio/visual alarm.

Automatic Reboot Trigger: Built-in watchdog timer, configurable for restarts at 1 to 255-second intervals

Warranty

Warranty Period: 3 years

Details: See www.moxa.com/warranty

Expansion Modules

Software-Selectable Serial Ports

	DA-SP08-I-DB	DA-SP08-DB	DA-SP08-I-TB	DA-SP38-I-TB
Serial Interface				
Number of Ports	RS-232/422/485 x 8			RS-422/485 x 8
Serial Standards	RS-232/422/485, software-selectable			RS-422/485
Connector	DB9 male	DB9 male	5-pin terminal block	
Protection	15 kV ESD and 2 kV isolation protection for all signals	15 kV ESD protection for all signals	15 kV ESD and 2 kV isolation protection for all signals	15 kV ESD and 2 kV isolation protection for all signals
Serial Signals				
RS-232	TxD, RxD, DTR, DSR, RTS, CTS, DCD, GND			N/A
RS-422	TxD+, TxD-, RxD+, RxD-, GND			
RS-485 4-wire	TxD+, TxD-, RxD+, RxD-, GND			
RS-485 2-wire	Data+, Data-, GND			
Data bits	5, 6, 7, 8			
Stop bits	1, 1.5, 2			
Parity	None, Even, Odd, Space, Mark			
Flow Control	RTS/CTS, XON/XOFF, RS-485 ADDCTM			

Time Synchronization and DI/DO Ports

	DA-IRIGB-4DIO-PCI104-EMC4
IRIG-B signal input	1 x differential TTL and ground
Connector	DB9 Male
Digital input and digital output	3 x DIs and 4 x DOs
Connector	DB9 Male

Ethernet Switching Port

	DA-SW08-RJ
Switch Port	8 x auto-sensing unmanaged 10/100 Mbps
Connector	RJ45 connector
Protection	1.5 kV magnetic isolation protection

Universal PCI Slot

	DA-UPCI-DK
Fit-in System	DA-682A-DPP Series
PCI Slot	1
Interface Bus	32-bit Universal PCI (3.3 V and 5 V)

Hardware Installation

The DA-682A-DPP Series of embedded computers are compact and rugged, making them suitable for industrial applications. The LED indicators on the DA-682A-DPP allow users to monitor performance and identify trouble spots quickly, and the multiple ports provided can be used to connect a variety of different devices. The DA-682A-DPP embedded computers come with a reliable and stable hardware platform that lets you devote the bulk of your time to application development. This chapter describes hardware installation and connector interfaces of the DA-682A-DPP embedded computers.

The following topics are covered in this chapter:

□ Placement Options

- Desk
- Rack Mounting

□ Wiring Requirements

□ Connecting the Power

- Wiring the Power Inputs

□ Reset Button

□ Front Panel LED

□ Connecting to a Display

□ Connecting USB Devices

□ Gigabit LAN Ports

□ Upgrading the Memory Module

□ Installing a CompactFlash Card

□ Installing a Disk on Module (DOM)

□ Installing SATA Hard Disks

□ Installing and Removing Expansion Modules

□ DA-SP08-I-DB/DA-SP08-DB/DA-SP08-I-EMC4-DB Serial Expansion Modules

□ DA-SP08-I-TB/DA-SP08-I-EMC4-TB Serial Expansion Modules

□ DA-IRIGB-4DIO-PCI104-EMC4 Module

- DA-IRIGB-4DIO-PCI104-EMC4 Pin Assignments
- Connecting a DA-IRIGB-B-S Module

Placement Options

Desk

Place your DA-682A-DPP on a clean, flat desk. For better ventilation, leave some space between the DA-682A-DPP and other equipment. Do not place equipment or objects on top of the DA-682A-DPP, as this might damage the computer’s internal components.

Rack Mounting

The DA-682A-DPP comes with a mounting kit for installing the embedded computer on a standard rack.



ATTENTION

- 1. For maximum safety, at least two persons should work together to lift, place, and install the computer on the rack.
- 2. Before you lift or move the computer, make sure that the power supply to the computer and the rack system are turned off.

Four screws are required to attach the DA-682A-DPP to a standard rack.

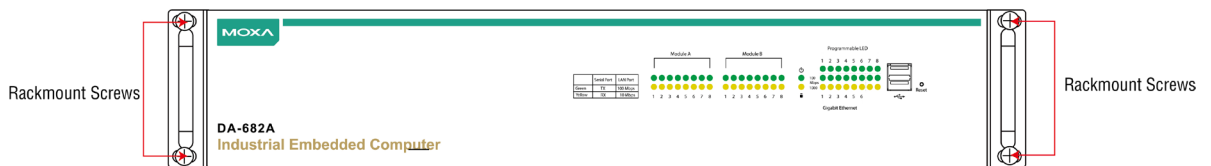

Step 1: Check the contents of the packages

Two supports, one for each side, are provided with the DA-682A-DPP. Each package should contain 1 bracket, 1 handle, 2 FSM5X10 screws, and 6 FSM4X6 screws. Remove the contents out of the packages.

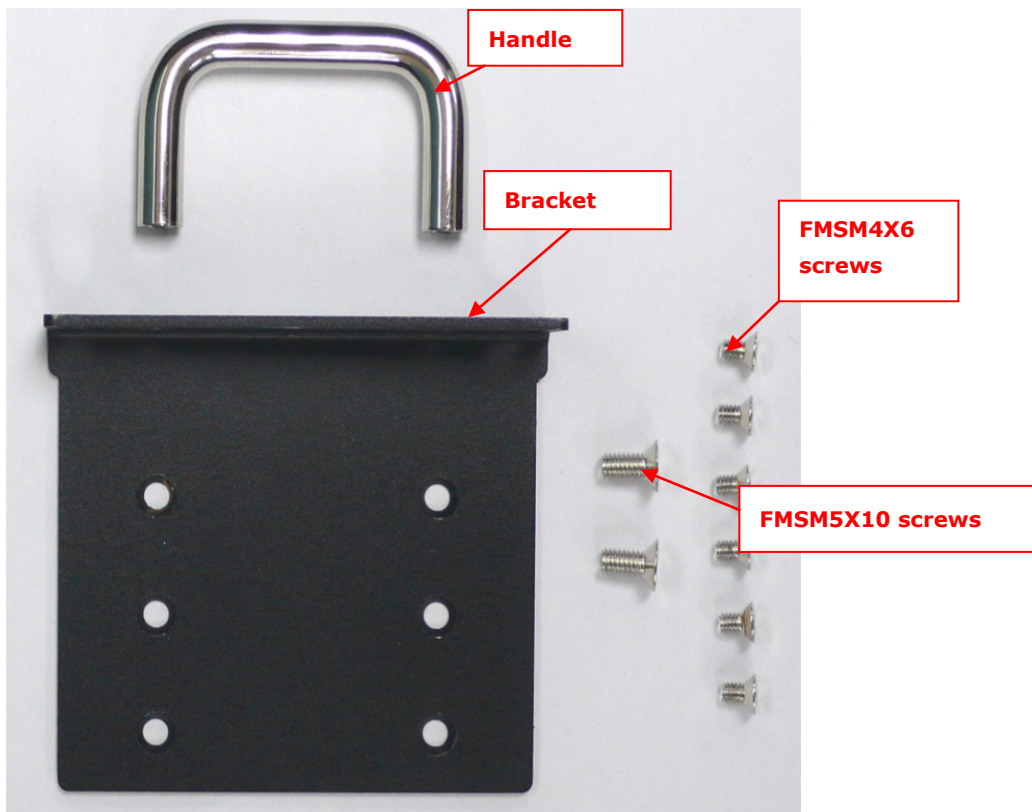

Step 2: Install the handles

Use 4 FMSM5X10 screws (2 on each bracket) to attach the handles to the brackets.



Step 3: Install the brackets

Use 6 FMSM4X6 screws to attach a bracket to one side of the DA-682A-DPP. Repeat this procedure on the other side.

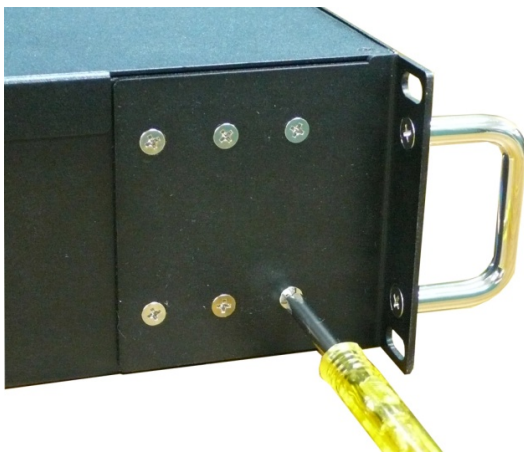

Step 4: Installing the DA-682A-DPP on a rack.

Gently slide the DA-682A-DPP onto the rack, and then use screws (provided by the rack supplier) to fix the bracket to the rail.



Use two screws on the left side and two screws on the right side. Check to make sure that the four screws are firmly attached to the rack.



Wiring Requirements

The following common safety precautions should be observed before installing any electronic device:

- Keep power wires and communications/signals wires in separate paths. If power and communications/signal wires must cross paths, make sure the wires are perpendicular at the intersection point.
- Use the type of signal transmitted through a wire to determine which wires should be bundled together and which kept separate. The rule of thumb is that wiring that carries similar electrical signals can be bundled together.
- We strongly recommend that you label the wiring for all devices in the system for easy identification.



ATTENTION

Do not run signal or communication wiring and power wiring in the same wire conduit. To avoid interference, wires with different signal characteristics should be routed separately.



ATTENTION

Safety First!

Be sure to disconnect the power cord before installing and/or wiring your device.

Electrical Current Caution!

Calculate the maximum possible current in each power wire and common wire. Observe all electrical codes dictating the maximum current allowable for each wire size. If the current goes above the maximum ratings, the wiring could overheat, causing serious damage to your equipment.

Temperature Caution!

Be careful when handling the unit. When the unit is plugged in, the internal components generate heat, and consequently the outer casing may feel hot to the touch.

Connecting the Power

After you have connected the power cords to the power input unit, the system will automatically boot up. Depending on the operating system, the boot up process can take about 30 to 60 seconds.

Wiring the Power Inputs

Pin Assignment

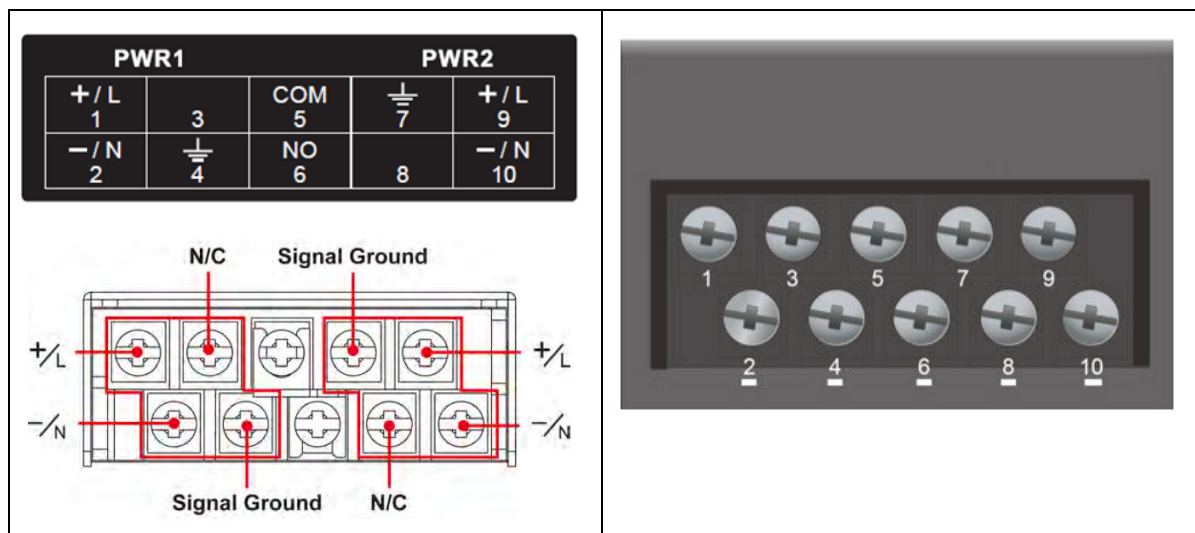

Power Input Wiring Description

Terminal Number	Description	Note
1	PWR1 Line/DC+	PWR1 Line/DC+ is connected to the positive (+) terminal if the power source is DC, or to the line terminal if the power source is AC.
2	PWR1 Neutral/DC-	PWR1 Neutral/DC- is connected to the negative (-) terminal if the power source is DC, or to the neutral terminal if the power source is AC.
3	NC	Reserved for future customization.
4	Signal Ground	Signal Ground should be connected to the ground terminal for AC power source 1.
5	COM	COM pin for the alarm relay.
6	NO	Normal open pin for alarm relay.
7	Signal Ground	Signal Ground should be connected to the ground terminal for AC power source 2.
8	NC	Reserved for future customization.
9	PWR2 Line/DC+	PWR2 Line/DC+ is connected to the positive (+) terminal if the power source is DC, or to the line terminal if the power source is AC.
10	PWR2 Neutral/DC-	PWR2 Neutral/DC- is connected to the negative (-) terminal if the power source is DC, or to the neutral terminal if the power source is AC.

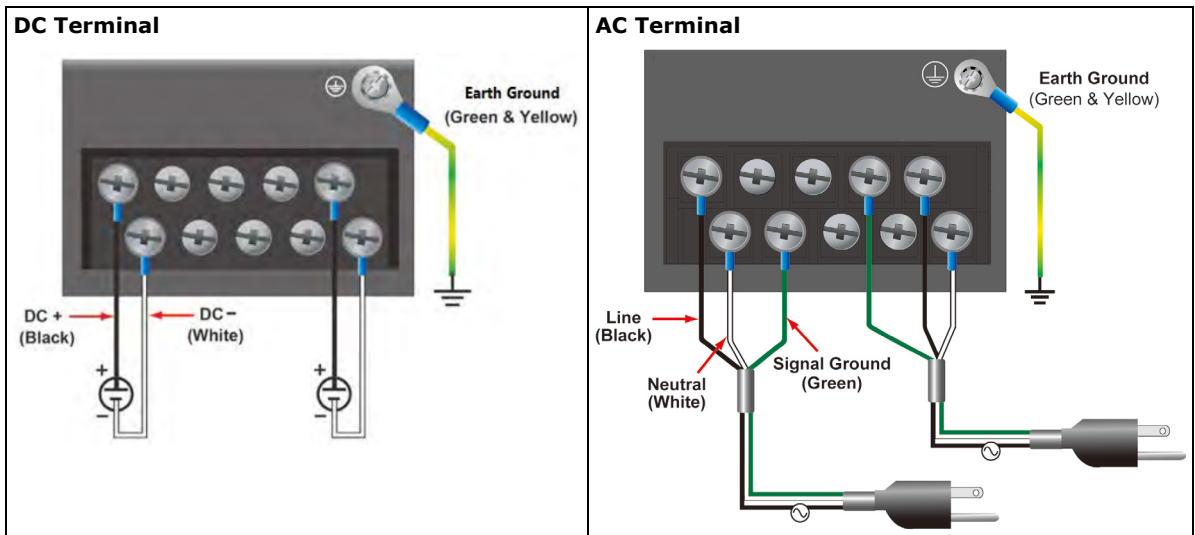

Reset Button

Pressing the Reset button initiates a hardware warm reboot. The button plays the same role as a desktop PC’s reset button. After you press the reset button, the system will reboot automatically. During normal use, you should NOT use the Reset Button. You should only use this button if the software is not working properly. To protect the integrity of data being transmitted or processed, you should always reset the system from the operating system with the software reboot function.

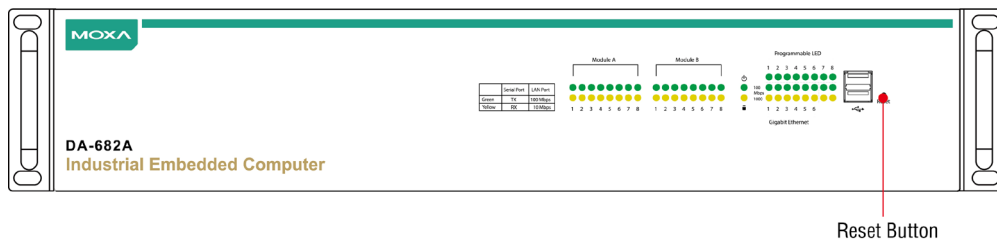

Front Panel LED

There are 58 LED indicators on the front panel, and 2 on the rear panel. Information about each LED is given in the following table.

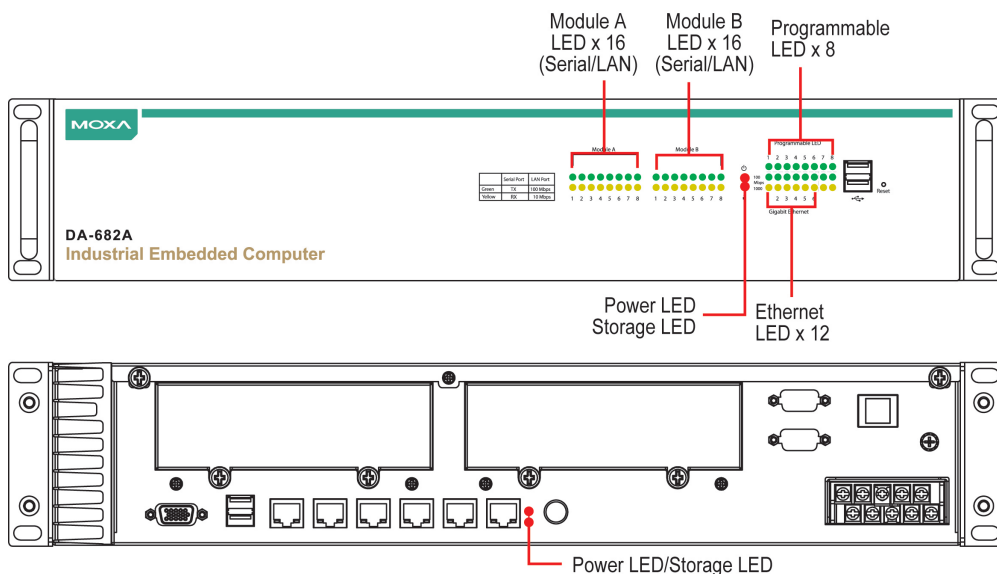

LED	Color	Description
Power	Green	Power is on
	Off	No power input or power error exists
Storage	Yellow/Blinking	Data is being written to or to read from the storage unit
	Off	Storage unit is idle
Gigabit LAN LEDs 1-6	Green	100 Mbps Ethernet mode
	Yellow	1000 Mbps (Gigabit) Ethernet mode
	Off	No operation or 10 Mbps Ethernet mode
Programmable 1-8	Green	Defined by users
Module A LEDs 1-8	Green	100 Mbps Ethernet mode or TX signal of serial port is active.
	Orange	10 Mbps Ethernet mode or RX signal of serial port is active.
	Off	No operation
Module B LED 1-8	Green	100 Mbps Ethernet mode or TX signal of serial port is active.
	Yellow	10 Mbps Ethernet mode or RX signal of serial port is active.
	Off	No operation

Connecting to a Display

The DA-682A-DPP embedded computer comes with a D-Sub 15-pin female connector to connect to a VGA monitor. Turn off the power source to the computer before you connect or disconnect the monitor cable.

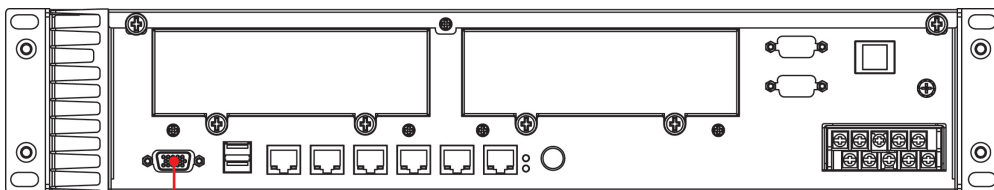

VGA

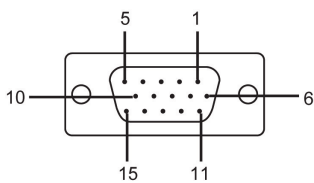

Pin No.	Signal Definition
1	RED
2	GREEN
3	BLUE
4	NC
5	GND
6	GND
7	GND
8	GND
9	VCC
10	GND
11	NC
12	DDC 2B Data
13	HSYNC
14	VSYSN
15	DDC 2B Clock

Connecting USB Devices

The DA-682A-DPP embedded computer has four USB 2.0 ports, with two ports on the front panel and the other two on the rear panel. All of the ports are UHCI, Rev 2.0 compliant and support Plug & Play and hot swapping. These ports can be used to connect USB devices, such as a keyboard, mouse, USB flash disk, and USB CD-ROM. In addition, both USB ports support system boot up, which can be activated by modifying the BIOS settings. Refer to Chapter 3 "BIOS Setup" for the configuration process.

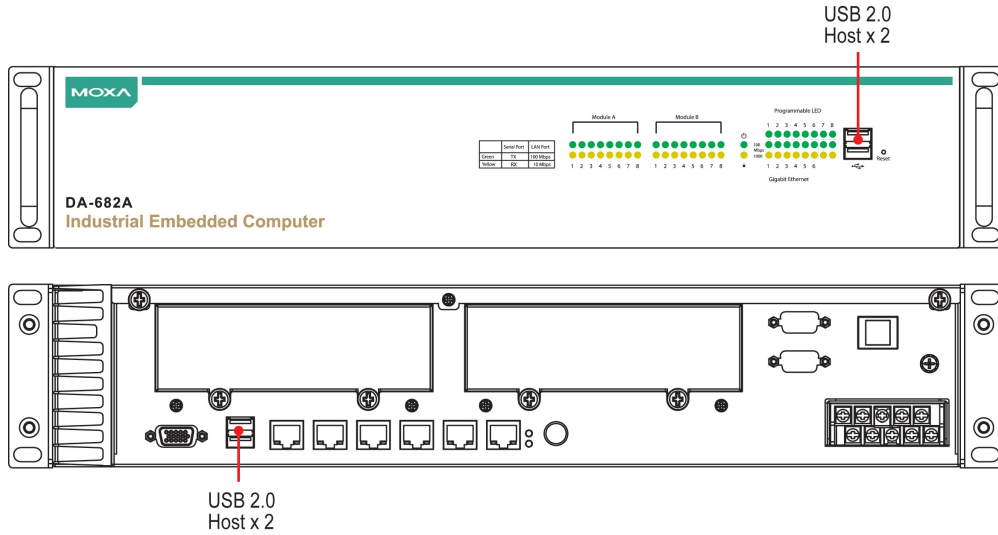

Gigabit LAN Ports

The DA-682A-DPP Basic System has 6 Gigabit LAN ports. When the cable is properly connected, the LEDs on the RJ45 connectors will glow to indicate a connection.

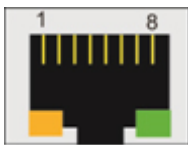
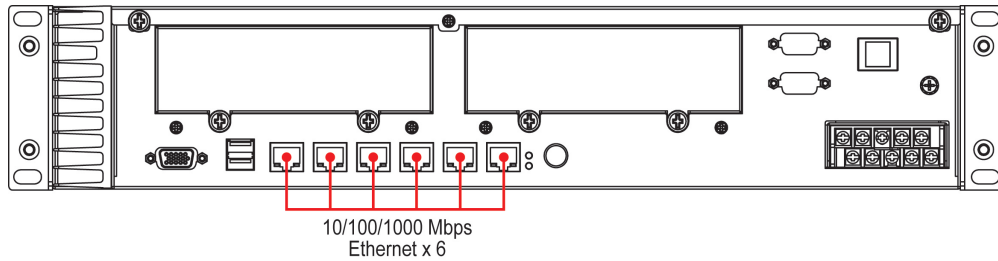

Pin	10/100 Mbps	1000 Mbps
1	Tx+	TRD(0)+
2	Tx-	TRD(0)-
3	Rx+	TRD(1)+
4	---	TRD(2)+
5	---	TRD(2)-
6	Rx-	TRD(1)-
7	---	TRD(3)+
8	---	TRD(3)-

LED	Color	Description
Gigabit RJ45 Connector	Green	100 Mbps Ethernet mode
	Yellow	1000 Mbps (Gigabit) Ethernet mode
	Off	Not operating or 10 Mbps Ethernet mode

The default IP addresses and netmasks of the Gigabit LAN ports are as follows:

	Default IP Address	Netmask
LAN 1	192.168.3.127	255.255.255.0
LAN 2	192.168.4.127	255.255.255.0
LAN 3	192.168.5.127	255.255.255.0
LAN 4	192.168.6.127	255.255.255.0
LAN 5	192.168.7.127	255.255.255.0
LAN 6	192.168.8.127	255.255.255.0

NOTE The W7E models use DHCP for IP address assignment.

Upgrading the Memory Module

The DA-682A-DPP embedded computer supports one DDR3 1333/1066 SODIMM module with up to 8 GB capacity. The computer is shipped with one DDR3 SDRAM memory module installed. To replace the SDRAM memory module, follow these instructions:

1. Disconnect the DA-682A-DPP from its power source.
2. Unfasten the screws on the back of the computer, and then remove the upper cover.



3. Find the location of the SDRAM memory socket.

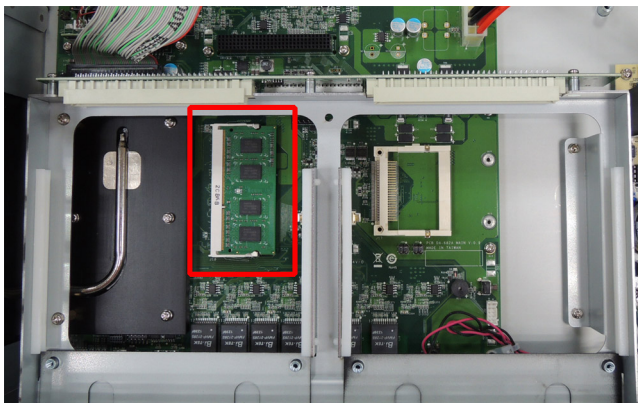

4. Push the two clutches of the socket and remove the existing memory module. Insert the new memory module into the socket in the correct direction and push down the memory module until the clutches have been securely fastened.

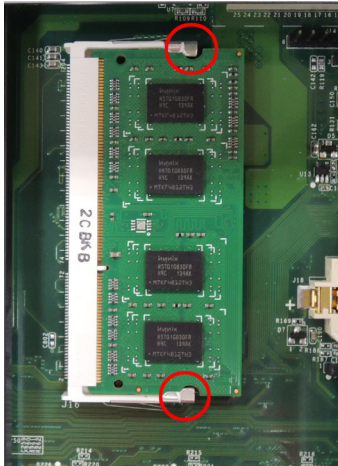

5. When finished, replace the upper cover of the computer, replace the screws, and fasten the screws to secure the cover.

Installing a CompactFlash Card

The DA-682A-DPP embedded computer comes with a CompactFlash socket. To insert a CompactFlash card, follow these instructions.

1. Disconnect the DA-682A-DPP from its power source.
2. Unfasten the screws on the back of the computer, and then take off the upper cover.



3. Find the location of the CompactFlash socket. The CompactFlash card socket is located in the middle of the main board.

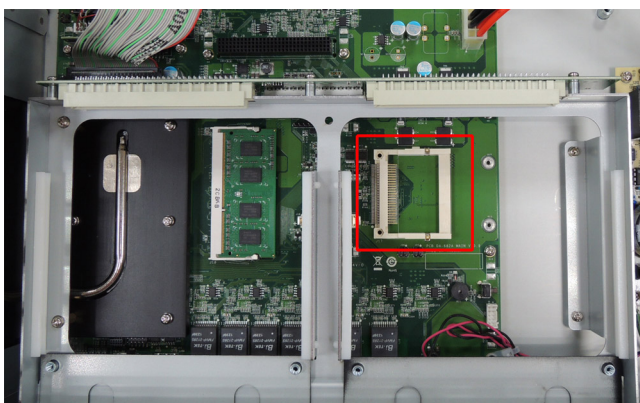

4. Insert the CompactFlash card into the socket.

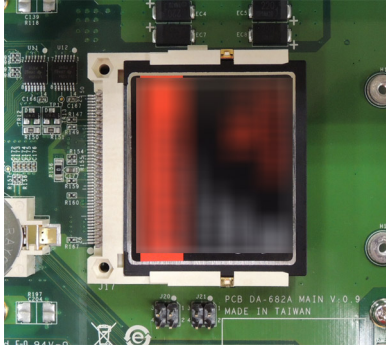

5. Replace the top cover of the computer and fasten the screws.



ATTENTION

You must disconnect or remove the power source before inserting or removing the CompactFlash card. The DA-682A-DPP rackmount computer does not support CompactFlash hot swap and PnP (Plug and Play) functions.

Installing a Disk on Module (DOM)

The DA-682A-DPP stores its operating system on a disk-on-module (DOM) that is pre-installed on the computer. You can also install your own DOM as per the following instructions:

1. Disconnect the DA-682A-DPP from its power source.
2. Unfasten the screws on the back of the computer, and then take off the upper cover.
3. Find the location of the DOM socket.

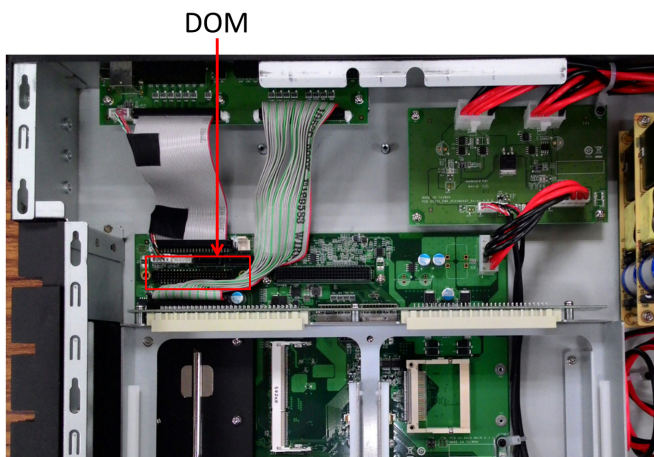

4. Remove the old DOM, and then insert the new DOM into the slot.
5. When finished, replace the upper cover of the computer and fasten the screws.

Installing SATA Hard Disks

The DA-682A-DPP computer comes with two SATA hard disk installation kits. You can install up to two SATA HDD/SSDs on the computer. The installation steps are as given below:

The SATA hard disk installation package contains one SATA power cable, one SATA data cable, one hard drive bracket for a single drive, four bracket screws, and four hard disk screws.

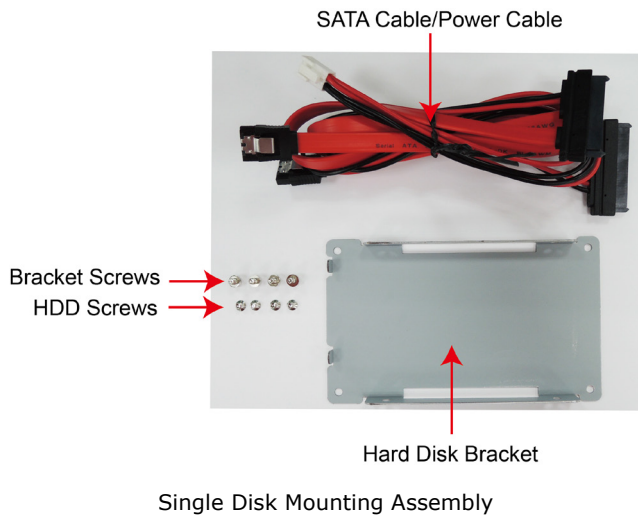

Step 1: Connect the SATA cables to the hard drive/drives.



Step 2: Place the hard drive/drives on the bracket. Make sure they are placed in the correct direction.

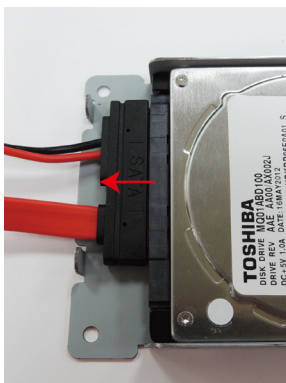

Step 3: Fasten the hard drive to the bracket using the HDD screws as shown below:

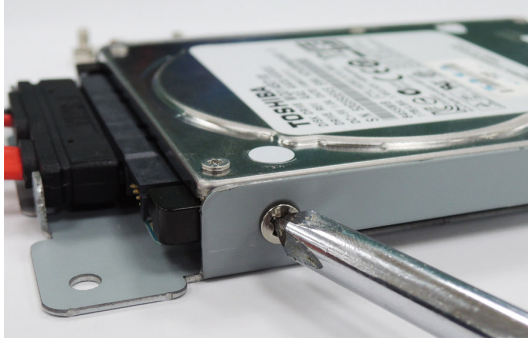

Single Disk Bracket

Step 4: Take off the upper cover of the computer, and find the locations of the HDD bracket and the SATA Cable/Power Cable.

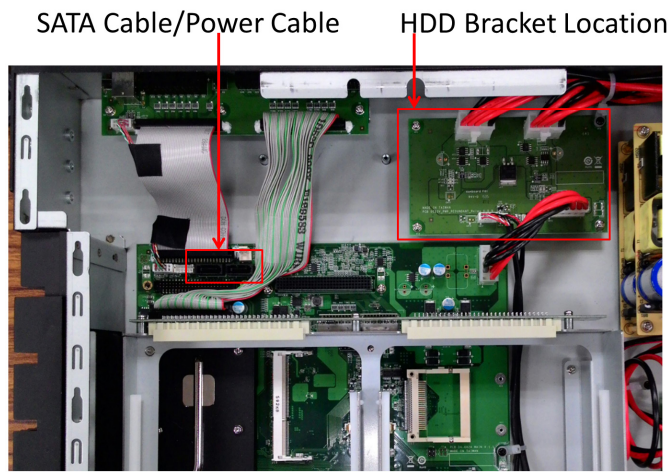

Step 5: Remove the Power Translation Board by removing the four screws that secure the board and detaching the 3 cables connected to the board.

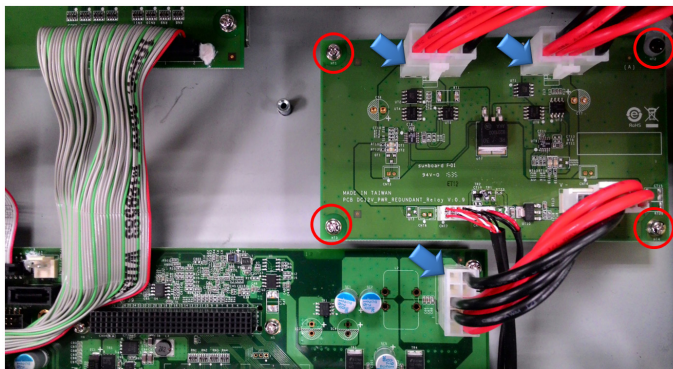

Step 6: Place the hard disk bracket (with the hard disk) face-down on the fixed spacers and secure the bracket using spacer screws as shown below:

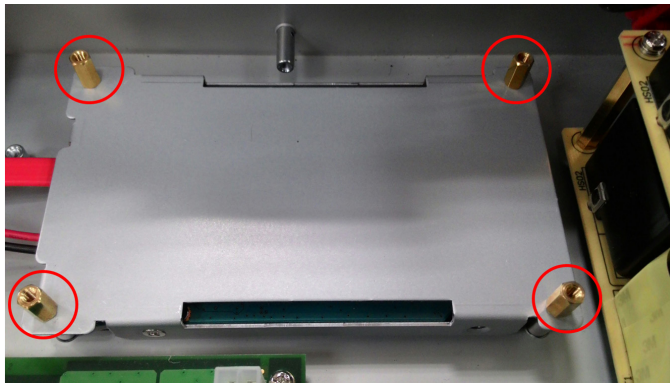

Step 7: Install the Power Translation Board firmly on the spacers and tighten the 3 bracket screws.



Step 8: Connect the 3 cables and tighten the final screw.

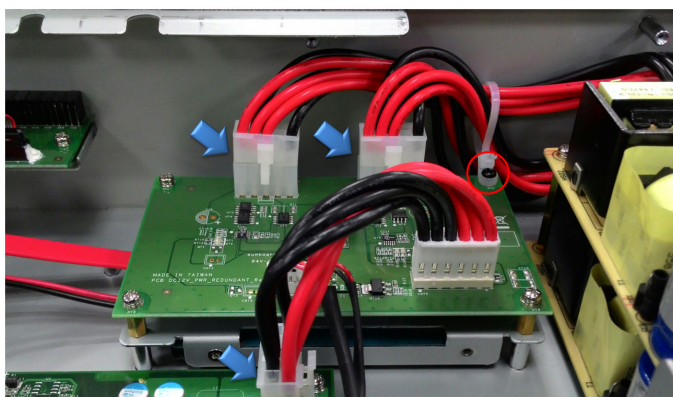

Step 9: Connect the cables to the appropriate jacks (power to the top one and data below).

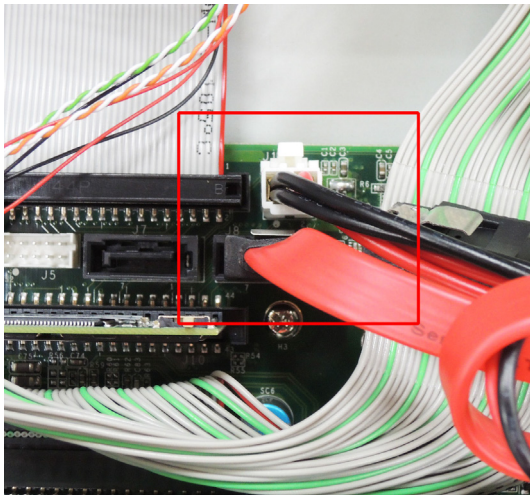

Single Disk

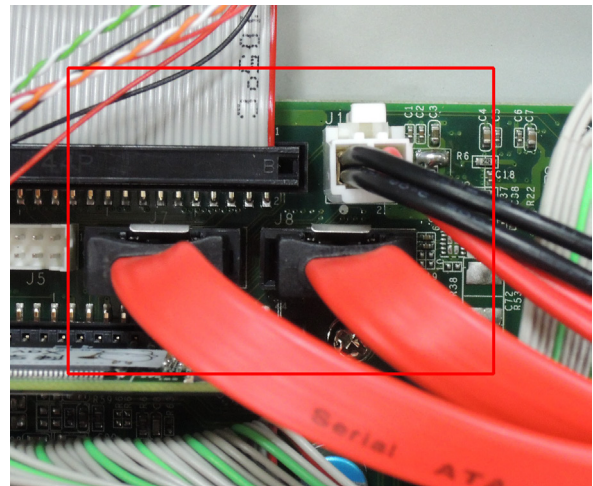

Dual Disks

Installing and Removing Expansion Modules

The DA-682A-DPP embedded computer has two slots for DA expansion modules. There is no designated primary or secondary slot; modules may be installed in either slot A or slot B. To install or remove expansion modules, follow these instructions:

1. Disconnect the DA-682A-DPP from the power source.
2. Unfasten the screws locking the covers of the expansion module A or module B on the rear panel.



Thumbscrews

Thumbscrews

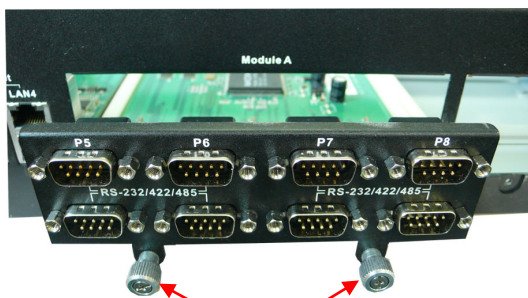

Apply pressure firmly but evenly here

3. Insert or remove the expansion module by carefully pushing or pulling, in unison, on the two thumbscrews. Be certain to apply pressure evenly across both screws, to ensure that the board is not damaged.

DA-SP08-I-DB/DA-SP08-DB/DA-SP08-I-EMC4-DB Serial Expansion Modules

The DA-SP08-I-DB, DA-SP08-I-EMC4-DB, and DA-SP08-DB serial expansion modules have 8 software-selectable serial ports with DB9 connectors. The DA-SP08-I-DB and DA-SP08-I-EMC4-DB support 2 kV isolation protection for all signals. In addition, the DA-SP08-I-EMC4-DB is able to withstand EMC level 4 interference. Each port can be configured by software for RS-232, RS-422, or RS-485.

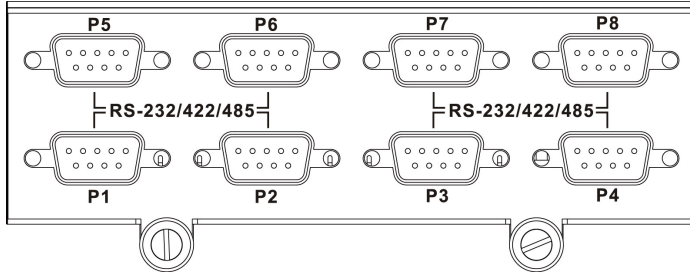

The pin assignments for the ports are shown in the following table:

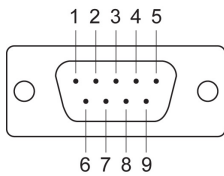

Pin	RS-232	RS-422	RS-485 (4-wire)	RS-485 (2-wire)	RS-232 (DA-SP08-I-EMC4-DB only)
1	DCD	TxDA(-)	TxDA(-)	-	-
2	RxD	TxDB(+)	TxDB(+)	-	RxD
3	TxD	RxDB(+)	RxDB(+)	DataB(+)	TxD
4	DTR	RxDA(-)	RxDA(-)	DataA(-)	-
5	GND	GND	GND	GND	GND
6	DSR	-	-	-	-
7	RTS	-	-	-	RTS
8	CTS	-	-	-	CTS

DA-SP08-I-TB/DA-SP08-I-EMC4-TB Serial Expansion Modules

The DA-SP08-I-TB and DA-SP08-I-EMC4-TB serial expansion modules have 8 software-selectable isolated serial ports with 5-pin terminal blocks. In addition, the DA-SP08-I-EMC4-TB is able to withstand EMC level 4 interference. Each port can be configured by software for RS-232, RS-422, or RS-485.

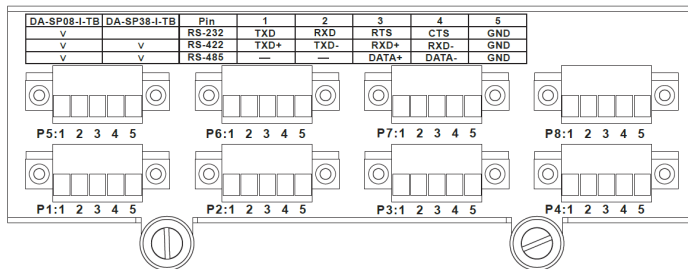

The pin assignments for the ports are shown in the following table:

Pin	RS-422	RS-485 (2-wire)	RS-232
1	TXD+	-	TXD
2	TXD-	-	RXD
3	RXD+	DATA+	RTS
4	RXD-	DATA-	CTS
5	GND	GND	GND

DA-IRIGB-4DIO-PCI104-EMC4 Module

The DA-682A-DPP models are provided with 1 PCI-104 socket for installing the optional expansion module, DA-IRIGB-4DIO-PCI104-EMC4 for the time-synchronization application.

	Model	Description
	DA-IRIGB-4DIO-PCI104-EMC4	Time synchronization expansion module, 1 IRIG-B signal input port, 3 digital inputs, 4 digital outputs (DA-681A-I-DPP series only)

DA-IRIGB-4DIO-PCI104-EMC4 Pin Assignments

Pin assignment for the male DB9 connectors to connect to an IRIG-B signal source, a digital input (DI) device, or a digital output (DO) device.

IRIG-B signal input

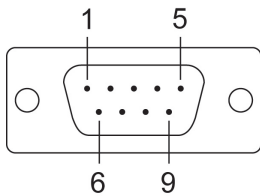

Pin	Differential	TTL
1	-	-
2	-	-
3	Data+	TTL
4	Data-	GND
5	-	-
6	-	-
7	-	-
8	-	-
9	-	-

Digital Input and Digital Output

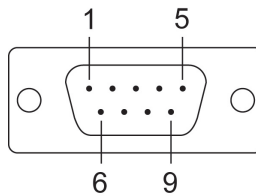

Pin	3DIs, 4DOs
1	DO 0
2	DO 1
3	DO 2
4	DO 3
5	DO COM
6	DI 0
7	DI 1
8	DI 2
9	DI Source

Connecting a DA-IRIGB-B-S Module



ATTENTION

To prevent damage to your system or the main board, make sure that you turn off the embedded computer before installing the DA-IRIGB-B-S Series module.

1. Turn the embedded computer off.
2. Remove the cover of the computer.
3. Remove the two screws for the PCI-104 socket.

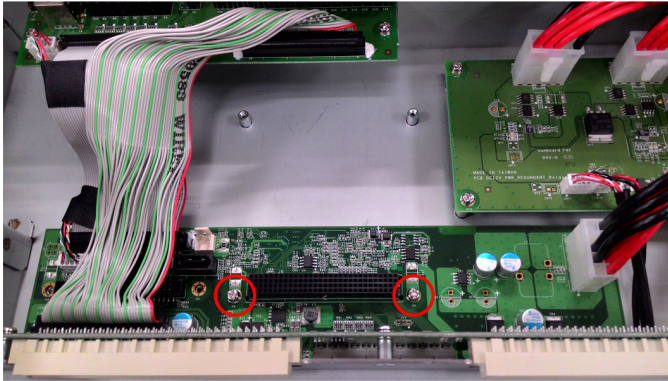

4. Install the four spacers for the PCI-104 socket as shown below:

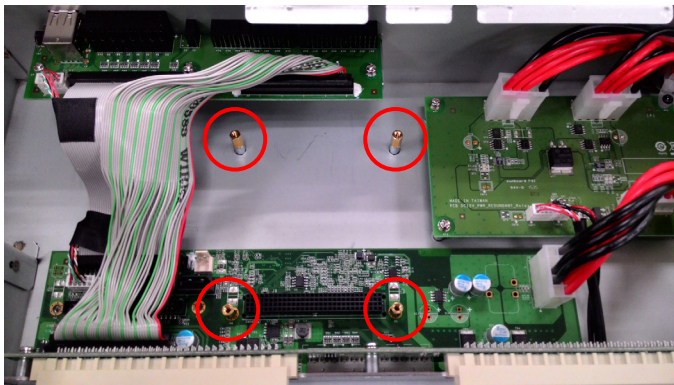

5. Place the DA-IRIGB-4DIO-PCI104-EMC4 module on the spacers and tighten the screws.

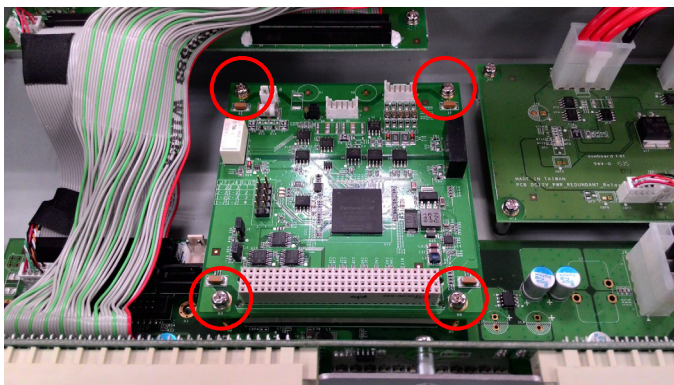

6. Connect the cables and complete the following actions:
 - a. Connect the 2-wire IRIG-B input signal cable.
 - b. Connect the 4-wire IRIG-B output signal cable.

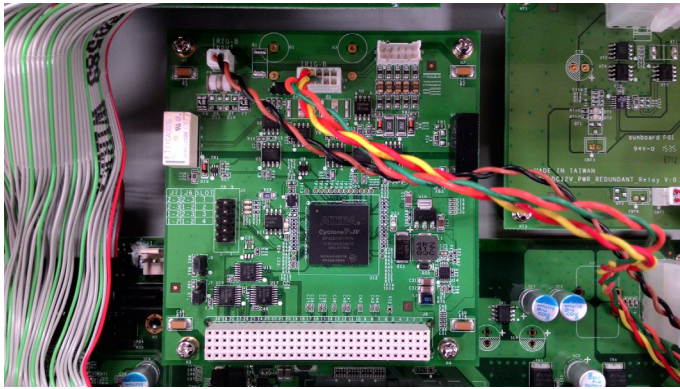

- c. Install the DB9 connectors on the rear panel of the embedded computer and replace the computer cover.



- 7. Turn on the embedded computer. The BIOS will automatically set the IRQ and I/O address.

BIOS Setup

This chapter describes the BIOS settings of the DA-682A-DPP computer. The BIOS is a set of input/output control routines for peripherals. The BIOS is used to initialize system peripherals before the operating system is loaded. The BIOS setup allows the user to modify the system configurations of these peripherals' basic input/output.

The following topics are covered in this chapter:

❑ **Entering the BIOS Setup**

❑ **Main Information**

❑ **Advanced Settings**

- Boot Configuration
- HDC Configuration
- Video Configuration
- Chipset Configuration
- Hardware Monitor
- Smart Recovery Info

❑ **Security Settings**

- Set Supervisor Password

❑ **Power Settings**

- Turbo Mode
- Auto Wake on S5
- Wake on LAN

❑ **Boot Settings**

- Boot Type
- PXE Boot to LAN
- Add Boot Options
- USB Boot
- EFI Device First
- Boot Delay Time
- Legacy

❑ **Exit Settings**

- Exit Saving Changes
- Save Change Without Exit
- Exit Discarding Changes
- Load Optimal Defaults
- Load Custom Defaults
- Save Custom Defaults
- Discard Changes

❑ **Upgrading the BIOS**

Entering the BIOS Setup

To enter the BIOS setup utility, press the "F2" key while the system is booting up. The main **BIOS Setup** screen is displayed. The following four options are available:

Continue:	Continue to boot up
Boot Manager:	Select the device for booting up
Boot From File:	Select the UEFI boot up file
SCU:	Enter the BIOS configuration

Select **SCU** to enter the **BIOS configuration**.



When you enter SCU, a basic description of each function key is listed at the bottom of the screen. Refer to these descriptions to learn how to use them.

F1	General Help	↑ ↓ .	Select Item
F5/ F6	Change Values	← →	Select Menu
F9	Setup Defaults	ESC	Exit
F10	Save and Exit	EN TER	Select or go to Submenu.

The following BIOS configuration screen will be shown when you enter SCU option:

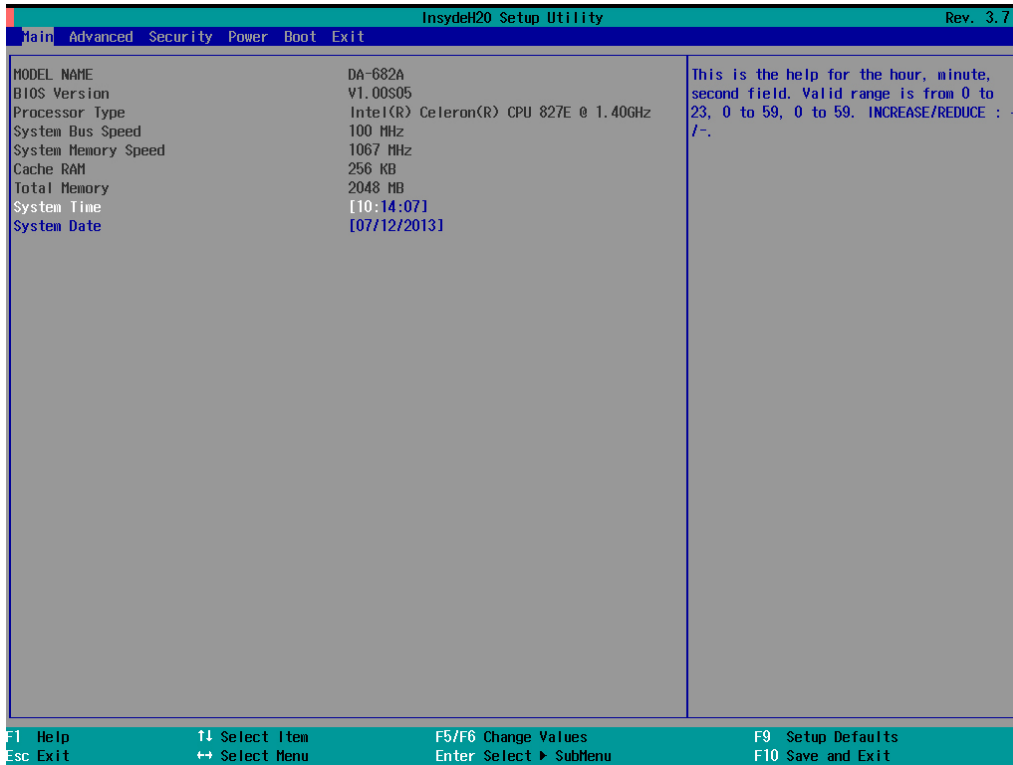

NOTE The information displayed for **Processor Type** may vary depending on the computer model that you have purchased.

Main Information

The **Main** page indicates the system information, such as model name, BIOS version, and CPU type. You can view the basic system hardware information on this page.

Advanced Settings

The **Advanced** option displays the advanced configuration such as Boot, HDC, Video, Chipset configuration, Hardware Monitor, and Information on the Smart Recovery feature.



Boot Configuration

This feature allows you to configure a default setting for the keys on the number pad of the computer keyboard. Turning the **NumLock** on allows you to use the number keys to type out numbers and turning the Num Lock off enables the key's other functions, such as using the keypad as an arrow pad.

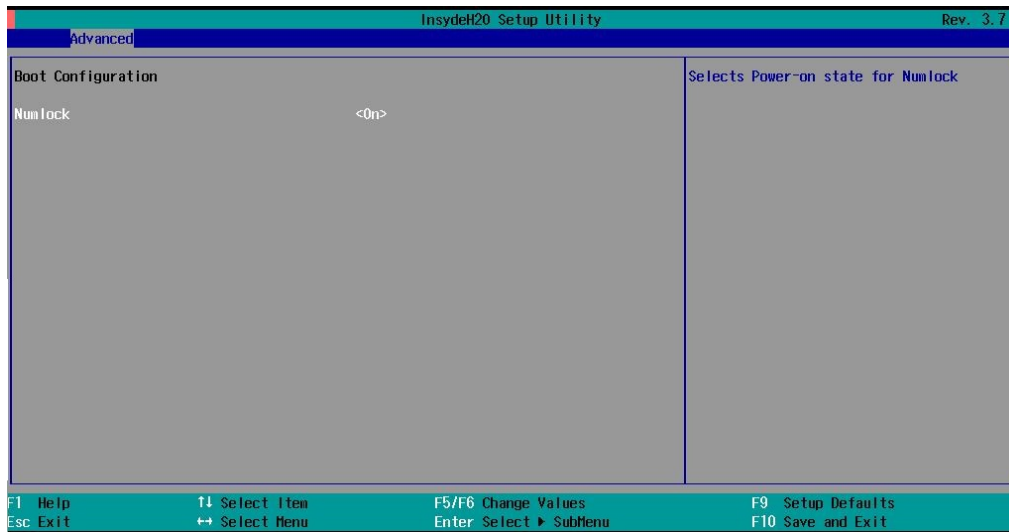

Option: On (default), Off.

HDC Configuration

The host drive controller can be configured for IDE (legacy default) or AHCI mode. When the legacy IDE mode is selected, the following screen is displayed.

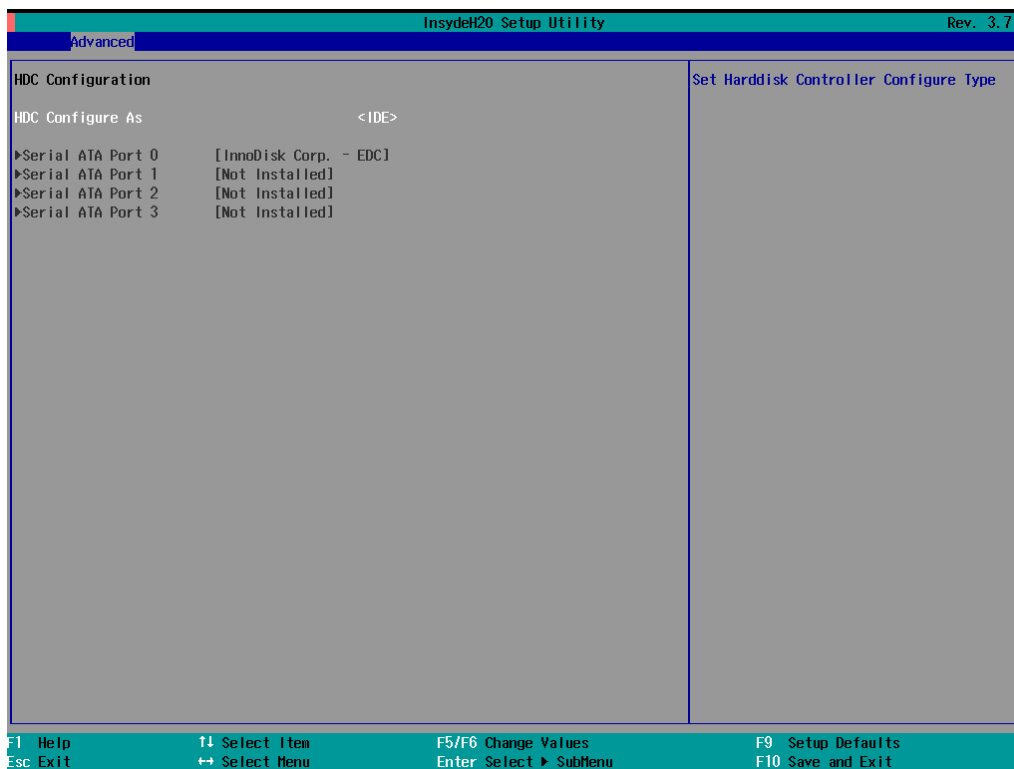

Serial ATA Port 0 to 3

This setting allows the user to display information about the installed drives.

AHCI SALP

Please note that the AHCI SALP option is only available when you select the AHCI mode. This option allows you to enable aggressive **link power management** (SALP) in AHCI. SALP enables the host bus adapter to conserve power by directly detecting when a SATA drive is no longer processing information and then immediately shifting it into suspended or sleep modes without waiting for software processes to initiate power-down processes.

Host Capability Register bit 26.

Options: Enabled (default), Disabled

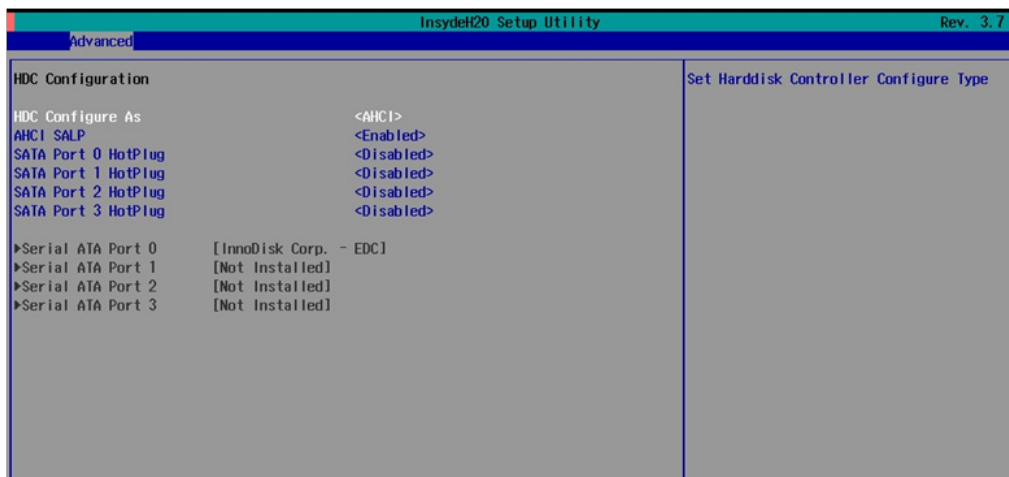

SATA Port 0 to 3 - HotPlug

This feature allows you to enable/disable hotplug capabilities (the ability to remove the drive while the computer is running) for installed storage drives.

Options: Disable (default), Enabled

Video Configuration

This feature allows you to configure the integrated graphics device (IGD) for functions like memory allocation (**DVMT**)

Internal Graphics Device

Allows you to enable/disable the internal graphics device.

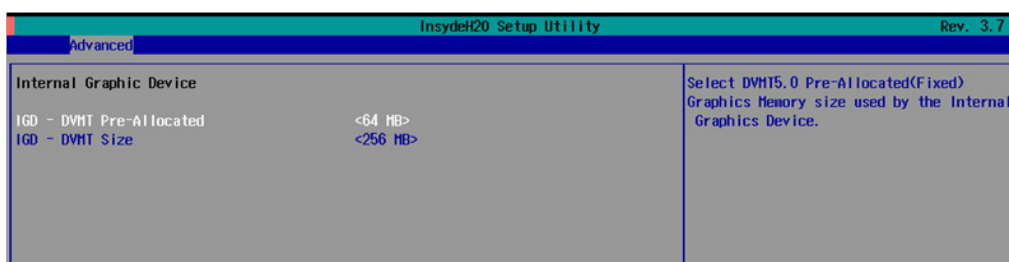

IGD—DVMT Pre-Allocated

Allows you to configure pre-allocated memory capacity for the IGD. Pre-allocated graphics memory is invisible to the operating system.

Options: 64 MB (default), 32 MB, 96 MB, 128 MB, 256 MB, 512 MB

DVMT is a BIOS solution where the optimum amount of memory is dynamically allocated and de-allocated as needed for balanced graphics and system performance, through Intel® Direct AGP and a highly efficient memory utilization scheme. DVMT ensures the most efficient use of available system memory resources for maximum 2D/3D graphics performance.

IGD—DVMT Size

Allows you to configure the maximum amount of memory DVMT will use when allocating additional memory for the internal graphics device.

Options: 256 MB (default), 128 MB, Max

Chipset Configuration

This feature allows you to configure the chipset settings.

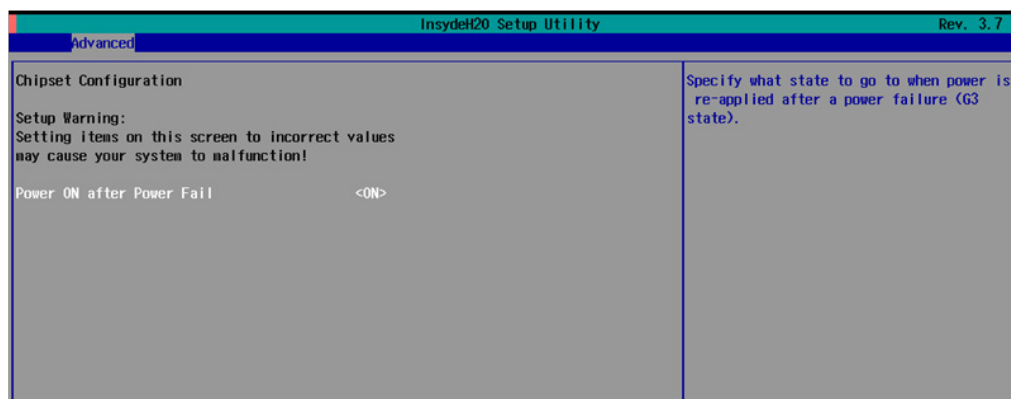

Power ON After Power Fail

Allows you to enable/disable the automatic power up of your computer after a system crash.

Options: ON (default), OFF, Last State

Hardware Monitor

This feature allows you to view hardware statistics like CPU and system temperature, voltage levels, and other chipset information.

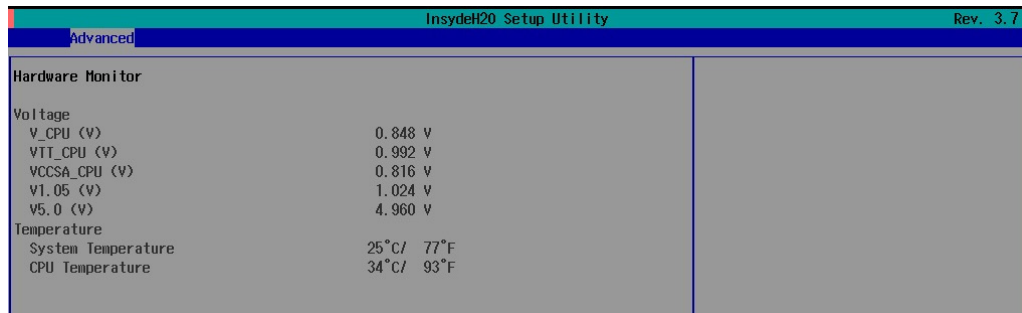

Please note that the voltage values will vary depending on the different models, and there will be 5% tolerance for the temperature values. Please also note that at 100°C the accuracy of CPU temperature readings are in the range of -5°C to +10°C. This deteriorates to -10°C to +15°C at 50°C. The CPU temperature readings saturates at some point below 50°C. Any CPU reading below 50°C is unreliable, and may only be interpreted as indicating a temperature below 50°C. For system temperature, there will be 5% tolerance for the temperature values.

Smart Recovery Info

This feature allows you to view the smart recovery settings for your computer.



Load Smart Recovery Default

Allows you to load the Smart recovery default value. For details on the Smart Recovery feature, refer to the *Smart Recover User's Guide*.

Options: Yes (default), No

Security Settings

This feature allows you to configure security settings with a supervisor password and user password.

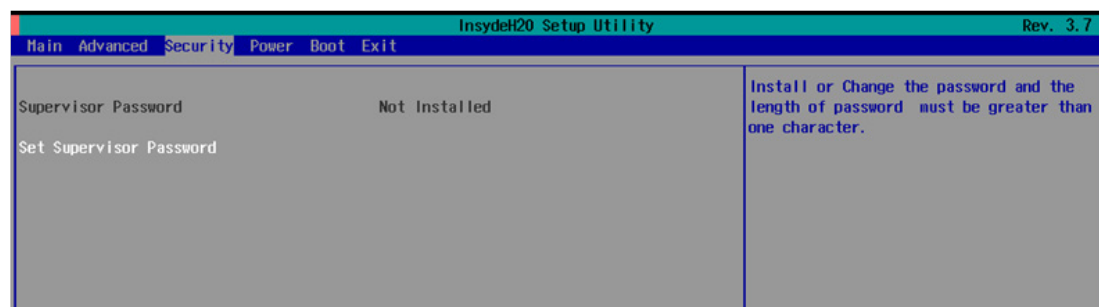

Set Supervisor Password

Allows you set the supervisor password.

To set the password, enter the password, and then confirm the password again.

To delete the password, enter **Set Supervisor Password** and enter the old password. Leave the new password fields blank, and press Enter.

Set Supervisor Password

Please type in your new password []

Please confirm your new password []

Power Settings

The **Power** menu allows you to configure the power settings for your computer.

The **Advanced CPU Control** option is only available on i7 platform. The **C-States** option is disabled by default.

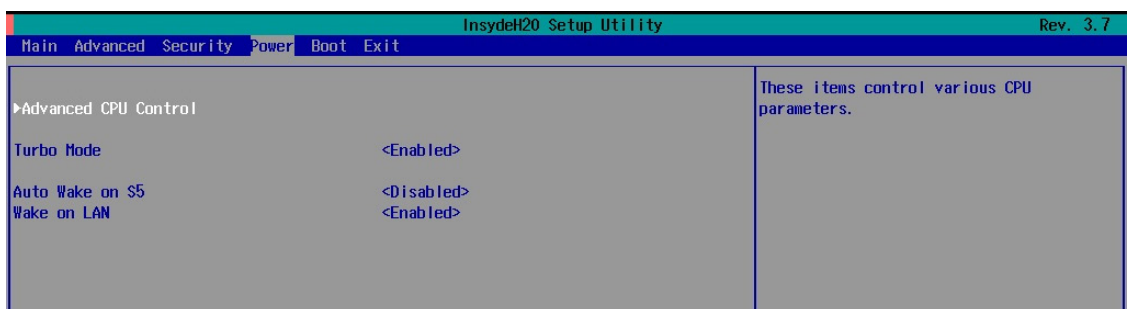
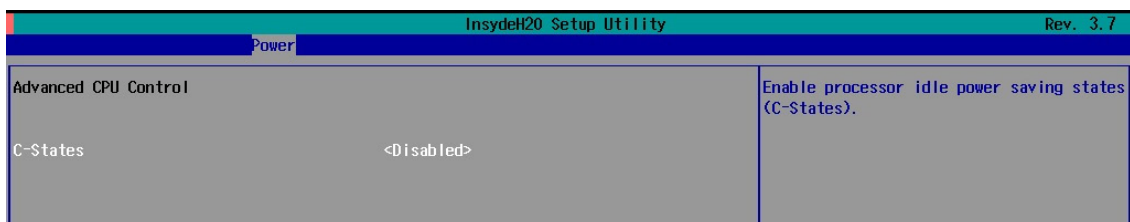

Turbo Mode

Allows you to enable/disable the Intel CPU Turbo Boost technology on your computer.

Options: Enabled (default), Disable.

Please note that this option is only available on the DA-682A-DPP-C7, DA-682A-DPP-C7-LX, and DA-682A-DPP-C7-W7E models.

Auto Wake on S5

This feature allows you to configure auto wake up from S5 status. S5 stands for Soft Off, where the PSU remains engaged but power to all other parts of the system is cut off. Auto-wake on S5 schedules a soft-reboot at certain periodic times that can be specified in the BIOS.

Options: Disabled (default); By Every Day (user specifies a regular daily time when the computer will power up); By Day of Month (user specifies a regular day each month when the computer will power up)

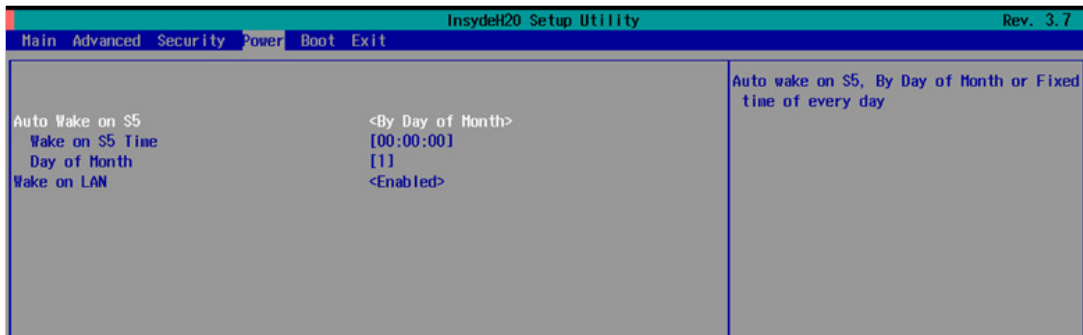

Wake on LAN

This feature is used to configure a wake on the system by a LAN device from a remote host.

Options: Enabled (default), Disable.

Boot Settings

The feature allows you to configure boot settings.



Boot Type

Allows you to enable/disable quick boot function.

Options: Dual Boot Type (default), Legacy Boot Type, UEFI Boot Type.

PXE Boot to LAN

Allows you to enable/disable PXE boot to LAN function.

Options: Disabled (default), Enabled

Add Boot Options

Allows you to add the boot order options for shell, network, and removable media.

Options: Last (default), First

USB Boot

Allows you to enable/disable USB boot function.

Options: Enabled (default), Disabled

EFI Device First

Allows you to determine EFI device first or legacy device first. If enabled, EFI device will be the first; if disabled, legacy device will be the first.

Options: Disabled (default), Enabled

Boot Delay Time

Allows you to configure the delay time value for users to input hot key during POST time.

Options: 0 Second (default), 3 Seconds, 5 Seconds, and 10 Seconds

Legacy

Normal Boot Menu

Allows you to configure the boot settings for your computer.

Options: Normal (default), Advance

Boot Type Order

Allows you to select the boot order. Use +/F5 (move up) or -/F6 (move down) to change values.

Options: Hard Disk Drive (default), CD/DVD-ROM Drive, USB, Others

Hard Disk Drive/USB Drive

Allows you to view devices such as hard disk drives, USB drives, or CD-ROMs installed on your computer. For example, if you have inserted a USB drive into the computer, it will be displayed in this window.

Exit Settings

The feature allows users to save configuration changes and exit the BIOS environment.



Exit Saving Changes

Allows you to exit the BIOS environment and save the values you have just configured.

Options: Yes (default), No

Save Change Without Exit

Allows you to save changes without exiting the BIOS environment.

Options: Yes (default), No

Exit Discarding Changes

Allows you to exit without saving any changes that might have been made to the BIOS.

Options: Yes (default), No

Load Optimal Defaults

Allows you to revert to the factory default BIOS values.

Options: Yes (default), No

Load Custom Defaults

Allows you to load custom default values for the BIOS settings.

Options: Yes (default), No

Save Custom Defaults

Allows you to save the current BIOS values as a custom default image. You can restore the system to this custom default image anytime using the **Load Custom Defaults** option.

Options: Yes (default), No

Discard Changes

Allows you to discard all settings you have just configured.

Options: Yes (default), No

Upgrading the BIOS

This section describes how to upgrade the BIOS.

IMPORTANT BIOS upgrades, if not done correctly, can permanently damage the computer. We strongly recommend that you contact Moxa's technical support staff for assistance in order to obtain all necessary tools and the most current advice before attempting to upgrade the BIOS on any Moxa device.

Step 1: Create a Bootable USB Disk

Before upgrading the BIOS, you must create a bootable USB RAM drive, which you can use as a system rescue device. A useful software suite, Rufus for creating a bootable USB RAM drives can be downloaded at:

<https://rufus.akeo.ie/>

To create a bootable USB disk using Rufus software, do the following:

1. Start Rufus and select the USB device that you want to use as a bootable disk from the **Device** drop-down list.
2. Select **MBR partition scheme for BIOS or UEFI computers** to boot from a legacy BIOS or UEFI.
3. Select **FAT (Default)** from **File system** drop-down list.
4. Select **16 kilobytes (Default)** for **Cluster size**.
5. Enter a drive name under **New volume label**.
6. Select the **Quick format, Create a bootable disk using FreeDOS**, and **Create extended label and icon files** format options.
7. Click **Start** to format and create the bootable USB drive.

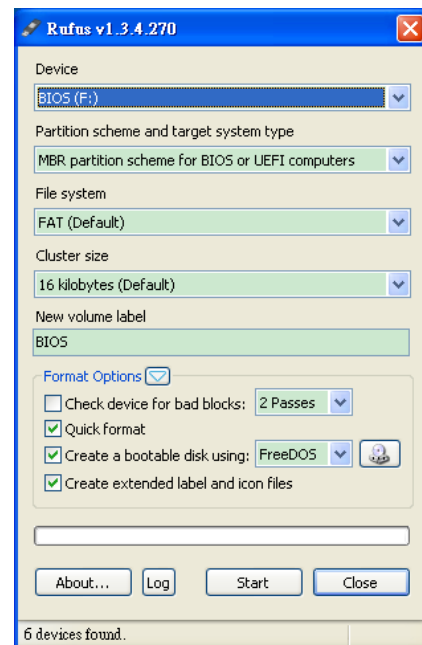

ATTENTION

We suggest you use a USB drive with under 2 GB disk space, as larger USB drives may not support FAT file format and consequently fail to boot.

Step 2: Prepare the Upgrade File

You must use the BIOS upgrade installation file to upgrade the BIOS. Contact Moxa's technical department for assistance.

1. Get the BIOS upgrade installation file. The file name should have following format: **682AxxSx.exe** (xx refers to version numbers).
2. Copy the file to the Bootable USB Disk.

Step 3: Run the upgrade program on the DA-682A-DPP Computer

1. Reboot the computer, press F12 while booting up to enter the Boot Manager
2. Select USB Disk as the first boot source. Press Enter to continue.



- When the boot up process is complete, the DOS screen is displayed. Go to the directory where the upgrade file is located. For example, if the upgrade file is stored in the DA682A folder, type **cd DA682A**

```
C:\>cd DA682A
```

- Run the upgrade program by typing **682A10S6.exe**. Please note that the upgrade filename will vary depending on the computer versions.

```
C:\ DA682A>682A10S6.exe
```

- Wait until the upgrade process is complete.

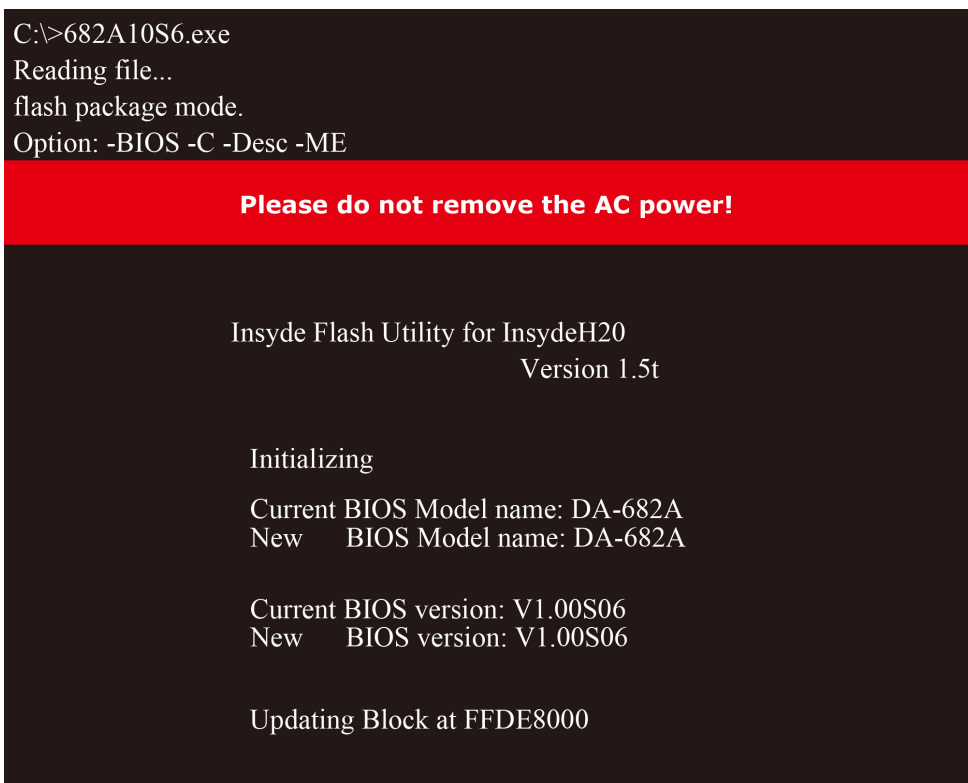

- When the upgrade is finished, the computer will automatically reboot. You can check the BIOS version on Main page of the BIOS Setup to confirm the upgrade.

MODEL NAME	DA-682A
BIOS Version	V1.00S06
Processor Type	Intel(R) Celeron(R) CPU 827E @ 1.40 GHz

**ATTENTION**

Do NOT switch off the power supply during the BIOS upgrade, since doing so may cause the system to crash.

A

Safety Installation Instructions

A. RTC Battery Warning

CAUTION: There is a risk of explosion if battery is replaced by an incorrect type. Dispose of used batteries according to the instructions.

B. Fuse Warning

CAUTION: For continued protection against fire, replace only with same type and rating of fuse.

C. Rackmount Warning

The following or similar rackmount instructions are included with the installation instructions:

(1) Elevated Operating Ambient: If installed in a closed or multi-unit rack assembly, the operating ambient temperature of the rack environment may be greater than the room ambient temperature. Therefore, consideration should be given to installing the equipment in an environment compatible with the maximum ambient temperature (T_{ma}) specified by the manufacturer.

(2) Reduced Air Flow: Installation of the equipment in a rack should be such that the amount of air flow required for safe operation of the equipment is not compromised.

(3) Mechanical Loading: Mounting of the equipment in the rack should be such that a hazardous condition is not achieved due to uneven mechanical loading.

(4) Circuit Overloading: Consideration should be given to the connection of the equipment to the supply circuit and the effect that overloading of the circuits might have on overcurrent protection and supply wiring. Appropriate consideration of equipment nameplate ratings should be used when addressing this concern.

(5) Reliable Grounding: Reliable grounding of rack-mounted equipment should be maintained. Particular attention should be given to supply connections other than direct connections to the branch circuit (e.g., by using power strips).