

BXP Series Quick Installation Guide

Embedded Computers

Version 1.0, September 2023

Technical Support Contact Information
www.moxa.com/support

MOXA[®]

© 2023 Moxa Inc. All rights reserved.

P/N: 1802001001010



Overview

The BXP Series wall-mount computers are powered by an Intel Atom®, Intel® Celeron®, or Intel® Core™ i5/i7 processor. The computers come with a rich set of interface options including up to 10 software-selectable RS-232/422/485 serial ports, up to 10 gigabit Ethernet ports, 4 digital inputs, and 4 digital outputs. The communication interfaces are located on the front and rear sides of the product, enabling easy access and expansion for industrial applications. A dual-storage design that includes CFast and SD slots enables easy storage expansion. The unique battery fastener cover design for the battery slot secures the battery in place and ensures stability in all operating environments.

Package Checklist

Each basic system model package is shipped with following items:

- BXP Series embedded computer
- Wall-mounting kit
- 2-pin terminal block for DC power
- 10-pin terminal block for DI/DO
- Quick installation guide (printed)
- Warranty card

NOTE Notify your sales representative if any of the above items are missing or damaged.

Hardware Overview

Front View

BXP-C100-C1-T/BXP-C100-C5-T/BXP-C100-C7-T Models

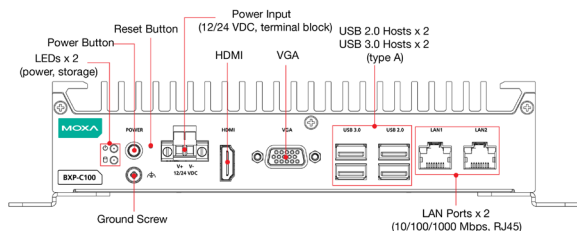

BXP-C100-C1-8L-T/BXP-C100-C5-8L-T/BXP-C100-C7-8L-T Models

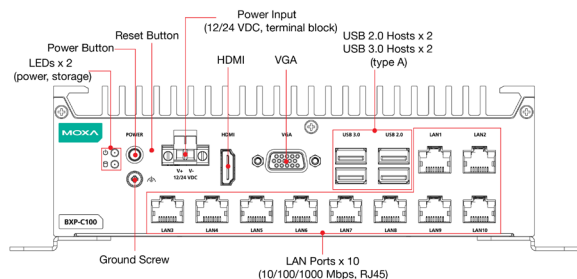

BXP-C100-C1-8C-T/BXP-C100-C5-8C-T/BXP-C100-C7-8C-T Models

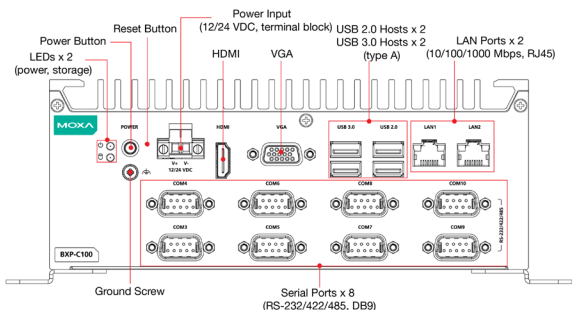

BXP-C100-C1-2L3C-T/BXP-C100-C5-2L3C-T/BXP-C100-C7-2L3C-T Models

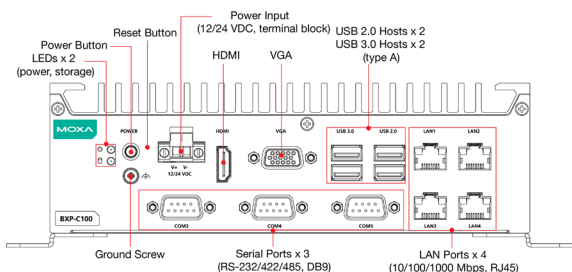

BXP-A100-E2-T/BXP-A100-E4-T Models

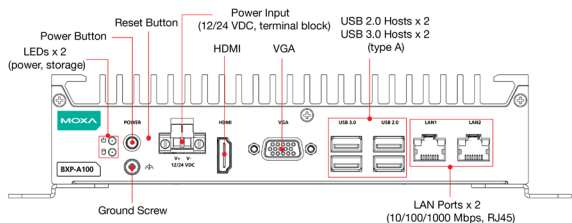

BXP-A100-E2-8L-T/BXP-A100-E4-8L-T Models

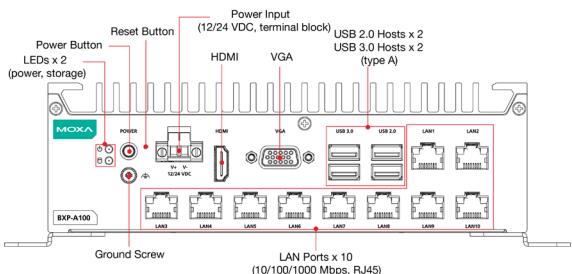

BXP-A100-E2-8C-T/BXP-A100-E4-8C-T Models

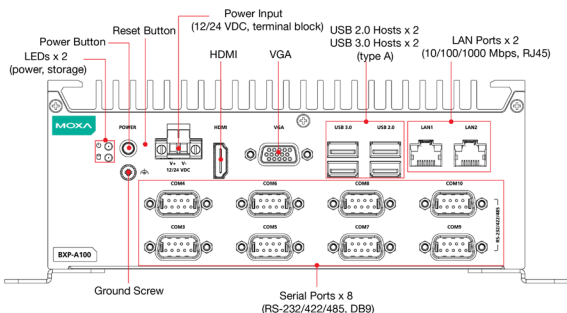

BXP-A100-E2-2L3C-T/BXP-A100-E4-2L3C-T Models

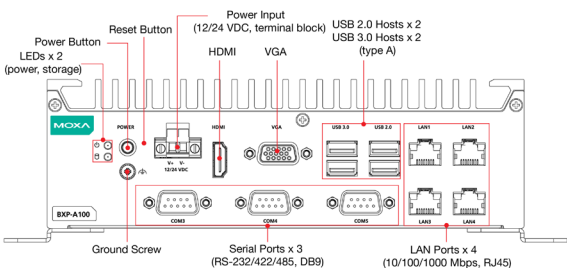

Rear View

BXP-C100-C1-T/BXP-C100-C5-T/BXP-C100-C7-T/BXP-A100-E2-T/BXP-A100-E4-T Models

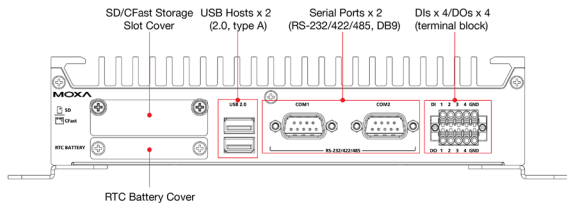

BXP-C100-C1-8L-T/BXP-C100-C5-8L-T/BXP-C100-C7-8L-T/BXP-A100-E2-8L-T/BXP-A100-E4-8L-T Models

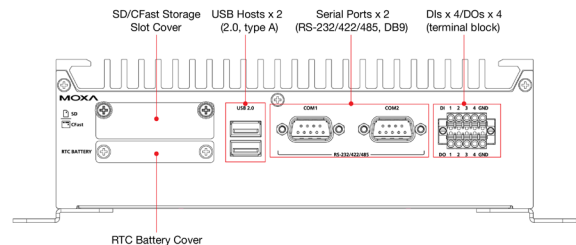

BXP-C100-C1-8C-T/BXP-C100-C5-8C-T/BXP-C100-C7-8C-T/BXP-A100-E2-8C-T/BXP-A100-E4-8C-T Models

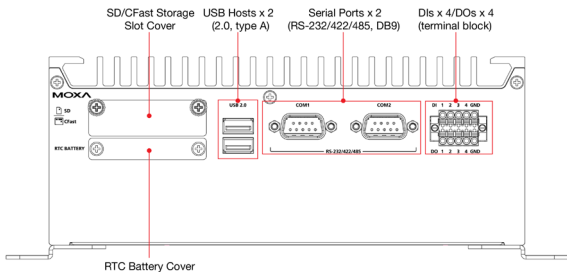

BXP-C100-C1-2L3C-T/BXP-C100-C5-2L3C-T/BXP-C100-C7-2L3C-T/BXP-A100-E2-2L3C-T/BXP-A100-E4-2L3C-T Models

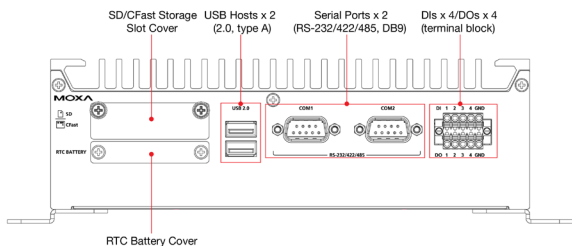

Dimensions

BXP-C100-C1-T/BXP-C100-C5-T/BXP-C100-C7-T/BXP-A100-E2-T/BXP-A100-E4-T Models

Unit: mm (inch)

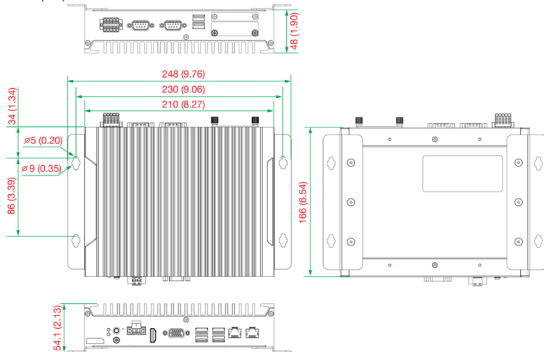

BXP-C100-C1-8L-T/BXP-C100-C5-8L-T/BXP-C100-C7-8L-T/BXP-A100-E2-8L-T/BXP-A100-E4-8L-T Models

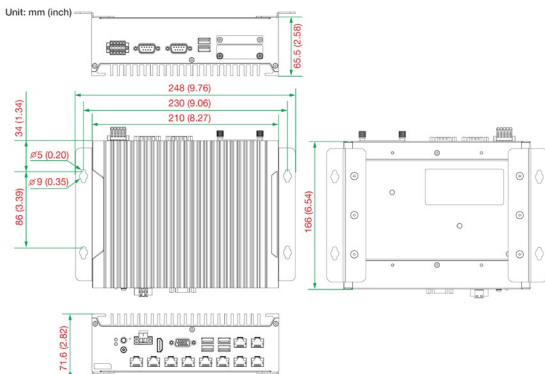

BXP-C100-C1-8C-T/BXP-C100-C5-8C-T/BXP-C100-C7-8C-T/BXP-A100-E2-8C-T/BXP-A100-E4-8C-T Models

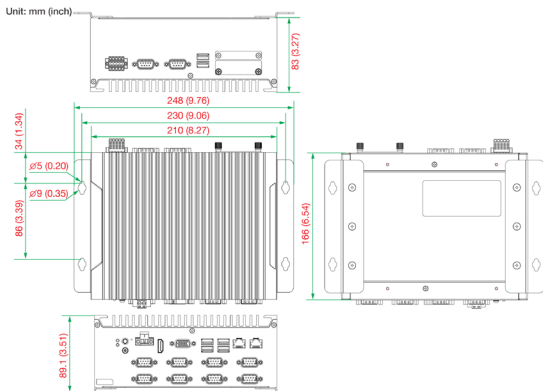

BXP-C100-C1-2L3C-T/BXP-C100-C5-2L3C-T/BXP-C100-C7-2L3C-T/BXP-A100-E2-2L3C-T/BXP-A100-E4-2L3C-T Models

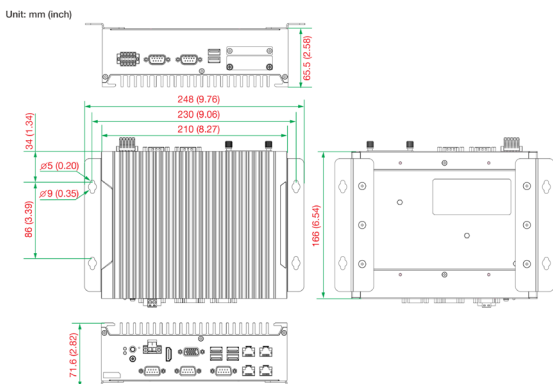

LED Indicators

The following table describes the LED indicators located on the front panel of BXP computers.

LED Name	Status	Function
Power	Green	Power is ON
	OFF	No power input or any other power error
Ethernet (10/100 Mbps) (1000 Mbps)	Green	Steady ON: 10/100 Mbps Ethernet link Blinking: Data is being transmitted or received
	Yellow	Steady ON: 1000 Mbps Ethernet link Blinking: Data is being transmitted or received
	OFF	No Ethernet connection
Storage (CFast)	Yellow	Blinking: Data is being accessed from the CFast card
	OFF	Data is not being accessed from the CFast card

Installing the BXP Computer

The BXP computer comes with two wall-mounting brackets. Attach the brackets to the computer using three screws on each side as indicated in the diagram.

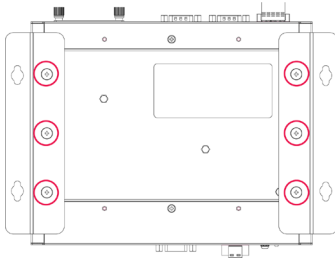

The six screws for the mounting brackets are included in the product package. Refer to the following illustrations for detailed specifications.

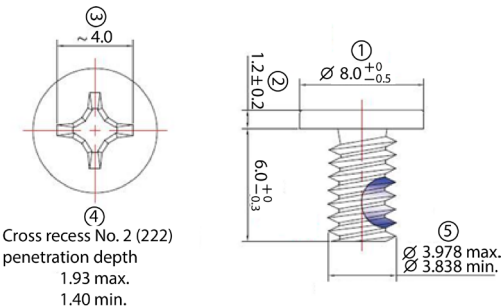

To mount a BXP computer to a wall or cabinet, use two screws on each side for the mounting brackets as shown in the illustration.

NOTE The four screws for attaching the wall-mounting brackets to the wall or cabinet are NOT included in the product package; they need to be purchased separately.

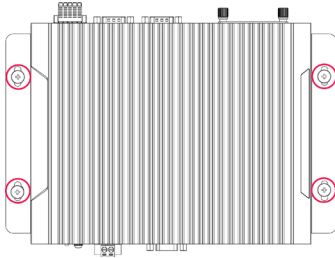

The specifications of the 4 screws to be purchased separately is indicated in the diagram.



After mounting the BXP computer using the wall-mounting kit and fastening the 4 screws to fix the mounting brackets to the wall or cabinet, push the computer downwards to ensure that the device is securely fixed to the mounting surface.

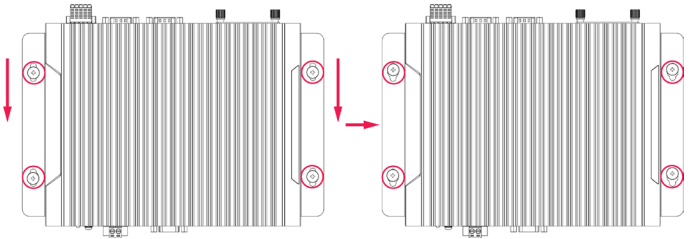

NOTE This computer is intended to be installed only in an area with restricted access. In addition, for safety reasons, the computer should be installed and handled only by qualified and experienced professionals.

Connecting the Power

The BXP computer is provided with 2-pin power input connectors in a terminal block on the front panel. Insert the power-cord wires into the connectors and tighten them to secure the wires in place. Push the power button. The power LED will light up to indicate that power is being supplied to the computer. It should take about 30 to 60 seconds for the operating system to complete the boot-up process.

Pin	Definition
1	V+
2	V-

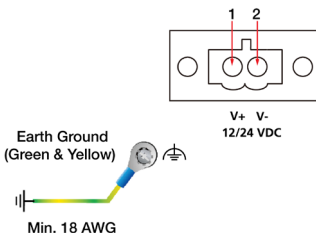

The power input specification is given below:

- The DC power source rating is 12 VDC @ 6.65 A or 24 VDC @ 3.30 A
- A minimum wire gauge of 18 AWG is required.

For surge protection, connect the grounding connector located below the power connector with the earth (ground) or a metal surface.

NOTE This computer is designed to be supplied by listed equipment rated 12 VDC (max)@6.65 A or 24 VDC (max)@3.30 A, and $T_{ma} = 60^{\circ}\text{C}$. If you need assistance with purchasing a power adapter, contact the Moxa technical support team.

NOTE If using Class I adapter, the power cord adapter should be connected to a socket outlet with an earthing connection or the power cord and adapter must comply with Class II construction.



ATTENTION

Before connecting the BXP computer to the DC power inputs, make sure the DC power source voltage is stable.

- The wiring for the input terminal block shall be installed by a skilled person.
- Wire type: Cu
- Only use 18-12 AWG wire size and a torque value of 0.5 N·m.
- Use only one conductor in a clamping point between the DC power source and the power input.



Warning

為避免電磁干擾，本產品不應安裝或使用於住宅環境。

Connecting Displays

The BXP computer comes with a VGA and a HDIM display output located on the front panel.

NOTE For highly reliable video streaming, use premium HDMI-certified cables.

Communications Connections

USB Ports

The BXP Series computer comes with 2 USB 3.0 ports and 2 USB 2.0 ports on the front panel. An additional 2 USB 2.0 ports are located on the rear panel. The USB ports can be used to connect to peripherals, such as keyboard, mouse, or flash drives for expanding the system's storage capacity.

Serial Ports

The BXP computer comes with 2 software-selectable RS-232/422/485 serial ports on the rear panel. Additional serial ports are located on the front panel. The ports use DB9 male connectors.

Refer to the following table for pin assignments:

Pin	RS-232	RS-422	RS-485 (4-wire)	RS-485 (2-wire)
1	DCD	TxDA(-)	TxDA(-)	-
2	RxD	TxDB(+)	TxDB(+)	-
3	TxD	RxDB(+)	RxDB(+)	DataB(+)
4	DTR	RxDA(-)	RxDA(-)	DataA(-)
5	GND	GND	GND	GND
6	DSR	-	-	-
7	RTS	-	-	-
8	CTS	-	-	-

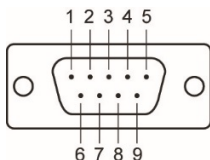

Ethernet Ports

The BXP computer has 2, 4, or 10 10/100/1000 Mbps Ethernet ports with RJ45 connectors on the front panel. Refer to the following table for the pin assignments:

Pin	10/100 Mbps	1000 Mbps
1	ETx+	TRD(0)+
2	ETx-	TRD(0)-
3	ERx+	TRD(1)+
4	-	TRD(2)+
5	-	TRD(2)-
6	ERx-	TRD(1)-
7	-	TRD(3)+
8	-	TRD(3)-



NOTE For reliable Ethernet connections, we recommend enabling the ports in standard temperatures and keeping them enabled in high/low temperature environment.

Digital Inputs/Digital Outputs

The BXP computer comes with four digital inputs and four digital outputs in a terminal block. Refer to the following figure for the pin definitions and the current ratings.

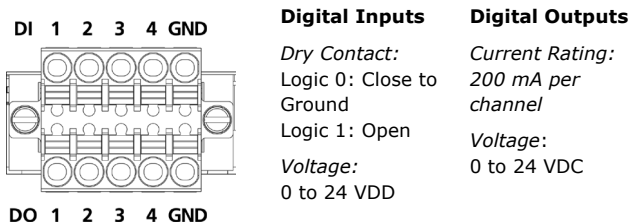

For detailed wiring methods, refer to the *BXP Series Hardware User Manual*.

SD / CFast Card

The BXP computer comes with two slots for plugging in an SD card and a CFast card.

To plug in the cards, do the following:

1. Remove the two screws that secure the slot cover.



2. Remove the cover and locate the SD and CFast card slots.

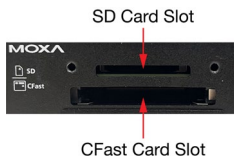

3. Insert the SD and CFast cards in the designated slots. Refer to the image printed beside the slots for the correct direction to insert the cards. When the cards are successfully inserted, you will hear a click.
4. To remove the cards, simply push them in to release them and take them out.

Replacing the Battery

The BXP computer comes with one slot for a battery on the rear panel of the computer. A lithium battery (3 V / 200 mAh) is preinstalled in the slot.

To replace the battery, do the following:

1. Unfasten the two screws on the battery cover.



2. Take off the cover.

The battery is attached to the slot cover as indicated in the image.

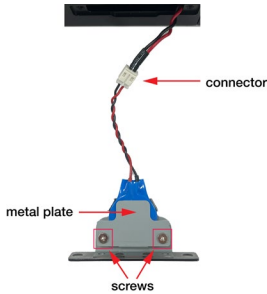

3. Unplug the connector of the battery-cover assembly from the internal wire of the slot.
4. Remove the two screws on the metal plate attached to the battery holder.



5. Place a new battery in the battery holder, replace the metal plate, and fasten the two screws on to the frame to secure the battery.

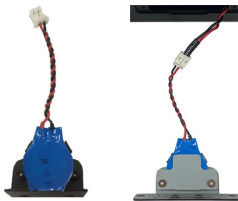

6. Plug in the connector of the battery-cover assembly to the internal wire of the slot.
7. Place the battery holder back in the slot and secure it by fastening the two screws on the cover.



Warning

- Be sure to use the correct type of battery. Incorrect battery may cause system damage. Contact Moxa's technical support staff for assistance, if necessary.
- To reduce the risk of fire or burns, do not disassemble, crush, or puncture the battery; do not dispose of in fire or water and do not short external contacts.

限用物質含有情況標示聲明書

限用物質含有情況標示聲明書

Declaration of the Presence Condition of the Restricted Substances Marking

設備名稱：嵌入式計算機		型號（型式）：BXP-C100-C7-T, BXP-C100-C7-8L-T, BXP-C100-C7-8C-T (及其系列型號)				
Equipment name		Type designation (Type)				
單元 Unit	限用物質及其化學符號 Restricted substances and its chemical symbols					
	鉛 Lead (Pb)	汞 Mercury (Hg)	鎘 Cadmium (Cd)	六價鉻 (Hexavalent chromium) (Cr ⁶⁺)	多溴聯苯 (Polybrominated biphenyls) (PBB)	多溴二苯醚 (Polybrominated diphenyl ethers) (PBDE)
外殼	○	○	○	○	○	○
印刷電路板及其電子組件	—	○	○	○	○	○
電纜/電線/連接器	—	○	○	○	○	○
金屬部件-金屬	—	○	○	○	○	○
機械部件-非金屬	○	○	○	○	○	○
備考 1. “超出 0.1 wt %” 及 “超出 0.01 wt %” 係指限用物質之百分比含量超出百分比含量基準 Note 1: “Exceeding 0.1 wt %” and “exceeding 0.01 wt %” indicate that the percentage content of the restricted substance exceeds the reference percentage value of presence condition.						
備考 2. “○” 係指該項限用物質之百分比含量未超出百分比含量基準值。 Note 2: “○” indicates that the percentage content of the restricted substance does not exceed the percentage of reference value of presence.						
備考 3. “—” 係指該項限用物質為排除項目。 Note 3: The “—” indicates that the restricted substance corresponds to the exemption.						

製造商資訊

Moxa 四零四科技股份有限公司

+886-3-2737575

桃園市八德區和平路 1111 號

產品型號

BXP-C100-C1-T	BXP-C100-C1-2L3C-T
BXP-C100-C1-T-Win10	BXP-C100-C5-2L3C-T
BXP-C100-C5-T	BXP-C100-C7-2L3C-T
BXP-C100-C5-T-Win10	
BXP-C100-C7-T	
BXP-C100-C7-T-Win10	
BXP-C100-C1-8L-T	
BXP-C100-C5-8L-T	
BXP-C100-C7-8L-T	
BXP-C100-C1-8C-T	
BXP-C100-C5-8C-T	
BXP-C100-C7-8C-T	