

# **MPC-2150 Series Quick Installation Guide**

---

**Version 3.1, January 2021**

**Technical Support Contact Information**  
**[www.moxa.com/support](http://www.moxa.com/support)**

**MOXA<sup>®</sup>**

© 2021 Moxa Inc. All rights reserved.

**P/N: 1802021500014**



## Overview

The MPC-2150, 15-inch panel computer, with 3<sup>rd</sup> generation Intel® Core™ processor delivers a reliable, durable, high-performance platform of wide versatility of use in industrial environments.

The MPC-2150 Series panel computers are designed with a wide -40 to 70°C temperature range, and come with a patented fanless, streamlined housing designed for highly efficient heat dissipation, making this computer one of most reliable industrial platforms available for harsh, hot, outdoor environments, such as are found at oil and gas fields and on drilling platforms.

The MPC-2150 also features a 1,000-nit LCD panel with a sunlight readable and projected capacitive glove-friendly multi-touch screen, providing an excellent user experience for outdoor applications.

## Package Checklist

Before installing the MPC-2150, verify that the package contains the following items:

- MPC-2150 panel computer
- 1 2-pin terminal block for DC power input
- SSD/HDD installation kit
- Quick installation guide (printed)
- Warranty card

*NOTE: Please notify your sales representative if any of the above items are missing or damaged.*

## Hardware Installation

### Front View

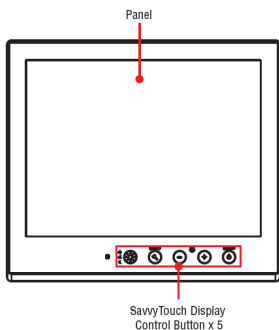



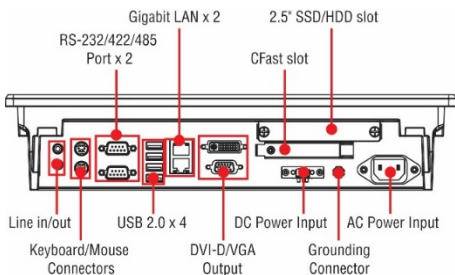

### Bottom View



## SavvyTouch Display Control Buttons

The following table describes the SavvyTouch display controls on the front surface of the MPC-2150. These intelligent controls will light up with a simple hand-wave above the area of the screen where they are located.

Name	Displayed Color	Control Function / Color Legend
 Power	Green	Power is on and functioning normally
	Red	Power standby and system shut down
	Off	Power is off.
 Brightness	White	+: To increase brightness of panel
		-: To decrease brightness of panel
 Info	Off	System functioning normally
	Red	System hardware error
 Storage	Red (on)	Storage drive is functioning properly
	Red (blinking)	Drive is accessing or writing data
	Off	Drive is offline.
 Display mode	White	Displays the brightness mode
	Off	Panel brightness out of ECDIS standard range

## Connector Description

### AC/DC Power Input

The MPC-2150 allows using either an AC or DC power input. When using AC power, use the standard C14 AC inlet. When using DC power, use at least a 60 W power adapter through the 2-pin terminal block in the accessories package. The figure shows the MPC-2150's DC pin assignments.

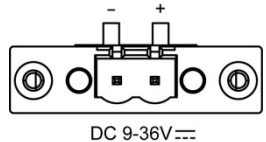

### Extending the Display

The MPC-2150 comes with both standard VGA (DB15) and DVI-D (DB29) interfaces (located on the bottom of the shell) which may be used to simultaneously extend the display across two monitors.

### Connecting to a Keyboard and Mouse

The MPC-2150 Series comes with two PS/2 connectors located on the bottom surface, for connecting a keyboard and a mouse.

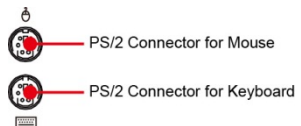

### Serial Ports

The MPC-2150 offers two software-selectable RS-232/422/485 serial ports over a DB9 connector. Refer to the MPC-2150 User's Manual for serial port configuration details. The pin assignments for the ports are shown in the table below:

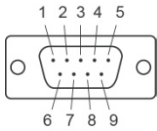

Pin	RS-232	RS-422	RS-485 (4-wire)	RS-485 (2-wire)
1	DCD	TxDA(-)	TxDA(-)	-
2	RxD	TxDB(+)	TxDB(+)	-
3	TxD	RxDB(+)	RxDB(+)	DataB(+)
4	DTR	RxDA(-)	RxDA(-)	DataA(-)
5	GND	GND	GND	GND
6	DSR	-	-	-
7	RTS	-	-	-
8	CTS	-	-	-

### **Ethernet Ports**

The pin assignments for the two Fast Ethernet 100/1000 Mbps RJ45 ports are shown in the following table:

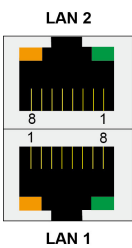

Pin	100 Mbps	1000 Mbps
1	ETx+	TRD(0)+
2	ETx-	TRD(0)-
3	ERx+	TRD(1)+
4	-	TRD(2)+
5	-	TRD(2)-
6	ERx-	TRD(1)-
7	-	TRD(3)+
8	-	TRD(3)-

Refer to the following table for a description of the LAN indicators:

LAN (on connectors)	Green	100 Mbps Ethernet mode
	Yellow	1000 Mbps (Gigabit) Ethernet mode
	Off	No activity / 10 Mbps Ethernet mode

### **Audio Interface**

The MPC-2150 comes with line-in and line-out audio jacks, allowing users to connect a speaker system, an earphone, or a microphone.

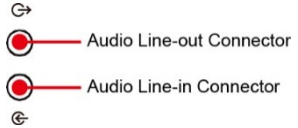

### **USB Ports**

Four USB 2.0 ports are available on the bottom surface. Use these ports to connect mass storage drives and other peripherals.

### **Installing a SATA HDD or SSD**

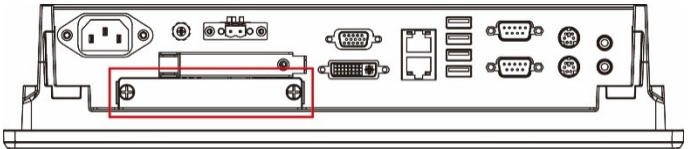

The MPC-2150 comes with an HDD/SSD installation kit accessory. To install the 2.5-inch SATA storage, follow these instructions. For better system reliability, we suggest using a solid state disk (SSD). A list of compatible SSD models is available on Moxa's website.

1. Use 4 screws to fasten the HDD/SSD to the HDD/SSD bracket.

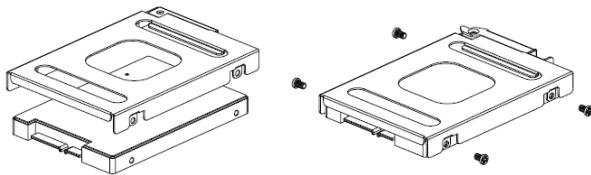

2. Remove the 2 screws holding the HDD/SSD cover to the MPC-2150.

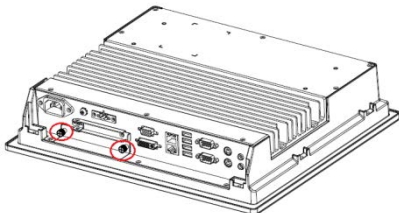

3. Insert the HDD/SSD (with the bracket) into the HDD/SSD slot. Noted that the latch on HDD/SSD bracket should be released when pushing the HDD/SSD into the slot.

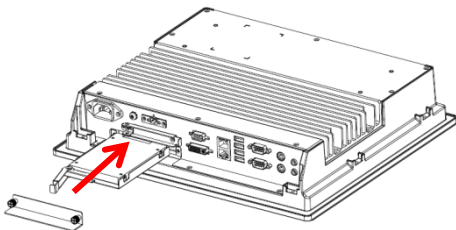

4. Reattach the HDD/SSD cover and fix it to the front panel with the 2 screws.

### **Installing a CFast Card**

The MPC-2150 has a CFast slot that can be used to install a standard CFast card using a push-push mechanism. A list of compatible CFast cards can be found on Moxa's website.

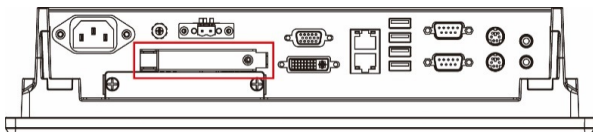

1. Loosen the screws connecting the HDD/SSD cover to the MPC-2150.
2. Insert the CFast card into the slot using the push-push mechanism.

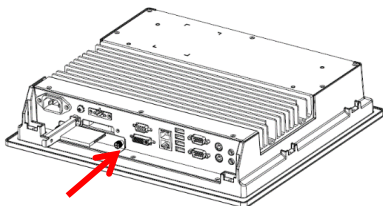

3. Reattach the CFast cover.

## **Real Time Clock**

The real time clock (RTC) is powered by a lithium battery. We strongly recommend that you do not replace the lithium battery without help from a qualified Moxa support engineer. If you need to change the battery, contact the Moxa RMA service team at [http://www.moxa.com/rma/about\\_rma.aspx](http://www.moxa.com/rma/about_rma.aspx).



### **ATTENTION**

There is a risk of explosion if the clock's lithium battery is replaced with an incompatible battery.

## **Powering on/off the MPC-2150**

To power on the panel computer you may either connect power by connecting the **Terminal Block to Power Jack Converter** to the terminal block and then connect a power adapter, or you may connect the computer to an AC power source using the power cord. After the power source is connected, touch the **Menu** button to turn the computer on. It takes about 10 to 30 seconds for the system to boot up.

To power off the MPC-2150 Series, touch the **MENU** button for 4 seconds; depending on your OS's power management settings you may enter **standby**, **hibernation**, or **system shutdown** mode. If you encounter technical problems, touch and hold the **MENU** button for 10 seconds to force a hard shutdown of the system.

## **Grounding the MPC-2150 Series**

Proper grounding and wire routing help to limit the effects of noise from electromagnetic interference (EMI). Run the ground connection from the ground screw to the grounding surface prior to connecting the power source.

## **Panel Mounting**

An optional panel mounting kit (MPC-MD-2-15-PMTK) is available for the MPC-2150 with 8 clamp mounts that allow for installation onto a wall (where space has been cut out to accommodate the rest of the hardware) or into computing stations where a flush mount is desired. The maximum thickness of the surface to which the computer will be clamped is 11 mm. For a secure mounting, all 8 clamps must be used. The clamp arms are fastened into slots on all four sides of the MPC-2150. Use the short M4 SUS (stainless) screws to fasten the clamp arms to the MPC-2150 mounting slots, as shown in the magnified inset in the diagram below. Next, use the clamps to fasten the computer to its mounting point. The torque value should not exceed 5 kg.

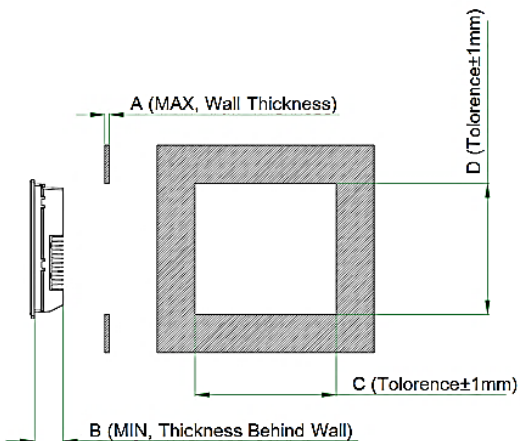

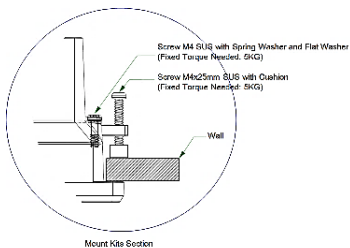
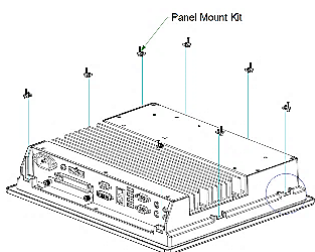

A	B	C	D	Mounting Kits (pcs)
8.0mm	65.0mm	339.0mm	294.0mm	8

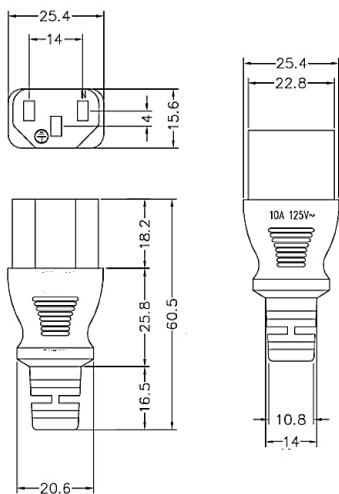

For a safe installation, we recommend using a plug with the following dimensions:



Rating	9-36 VDC, 8.3-1.8 A 100-240 VAC, 50-60 Hz, 0.7-0.4 A
ATEX information	  II 3 G DEMKO 16 ATEX 1665X Ex nA IIC T4 Gc Ambient Range: $-40^{\circ}\text{C} \leq T_a \leq +70^{\circ}\text{C}$ , or $-40^{\circ}\text{C} \leq T_{\text{amb}} \leq +70^{\circ}\text{C}$ Rated Cable Temp $\geq 90^{\circ}\text{C}$
IECEX Certificate no.	IECEX UL 16.0031X
HazLoc Standard	EN 60079-0: 2012+A11:2013/IEC 60079-0 6th Edition EN 60079-15: 2010/IEC 60079-15 4th Edition

### **Special Conditions of Use**

- Subject devices are intended for use in an area of not more than pollution degree 2 in accordance with EN 60664-1.
- The device needs to be shielded from direct exposure to UV light sources in final installation.
- Transient protection shall be provided to limit the rated voltage to maximum 140% of rated voltage.
- The audio in/out and keyboard/mouse connector are not to be used in hazardous locations.
- The detachable AC power supply cord connector (female) construction must be of type C13 in accordance with EN 61320-1 and same size/shape as in schedule drawing HAZLOC\_MPC-215\_ME\_014 to connect with the connector retainer. The other end of the power cord is with bare wire for field wiring to terminal block and shall be subject to investigation by the local authority having jurisdiction at the time of installation.
- This device is intended to be mounted on the flat surface of tool secured enclosures by eight wall mounting clamps with torque value 5 kgf.