

V2406C Series Quick Installation Guide

Embedded Computers

Version 1.2, September 2021

Technical Support Contact Information
www.moxa.com/support

MOXA[®]

© 2021 Moxa Inc. All rights reserved.

P/N: 1802024060042



Overview

The V2406C Series embedded computers are based on Intel® 7th and 8th Gen processors and feature 4 RS-232/422/485 serial ports, dual LAN ports, and 4 USB 3.0 ports. The V2406C computers come with 1 VGA output and 1 HDMI port with 4k resolution support. The computers comply with the EN 50155:2017 specifications, covering operating temperature, power input voltage, surge, ESD, and vibration, making them suitable for a variety of industrial applications.

The mSATA slot, SATA connectors, and USB ports provide the V2406C computers with the reliability needed for industrial applications that require storage expansion for data buffering. Most importantly, the V2406C computers come with 2 storage trays for inserting additional storage media, such as hard disk or solid-state drives, which support hot swapping for convenient, fast, and easy storage replacement. Each storage slot has its own LED that indicates whether a storage module is plugged in.

Package Checklist

Each basic system model package is shipped with following items:

- V2406C Series embedded computer
- Wall-mounting kit
- 2 HDD trays
- 8 screws for securing the HDD trays
- HDMI cable locker
- Quick installation guide (printed)
- Warranty card

Hardware Installation

Front View

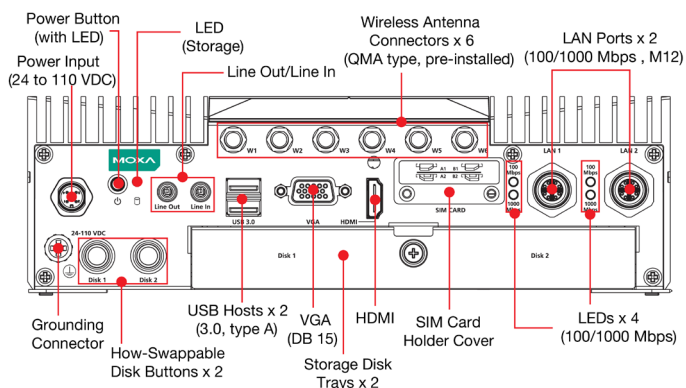

Rear View

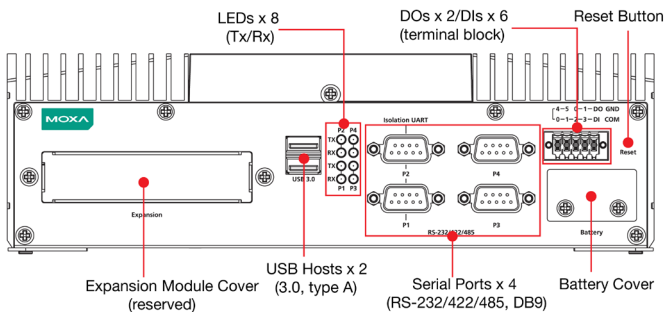

Dimensions

Unit: mm (inch)

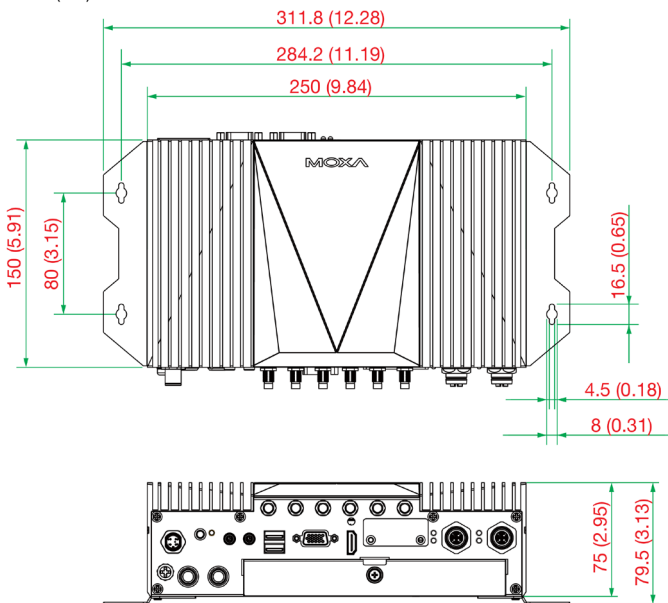

LED Indicators

The following table describes the LED indicators located on the front and rear panels of the V2406C computer.

LED Name	Status	Function
Power (On power button)	Green	Power is on
	Off	No power input or any other power error
Ethernet (100 Mbps) (1000 Mbps)	Green	Steady On: 100 Mbps Ethernet link Blinking: Data transmission is in progress
	Yellow	Steady On: 1000 Mbps Ethernet link Blinking: Data transmission is in progress

LED Name	Status	Function
	Off	Data transmission speed at 10 Mbps or the cable is not connected
Serial (TX/RX)	Green	Tx: Data transmission is in progress
	Yellow	Rx: Receiving Data
	Off	No operation
Storage	Yellow	Data is being accessed from either the mSATA or the SATA drives
	Off	Data is not being accessed from the storage drives

Installing the V2406C

The V2406C computer comes with two wall-mounting brackets. Attach the brackets to the computer using four screws on each side. Ensure that the mounting brackets are attached to the V2406C computer in the direction shown in the following figure.

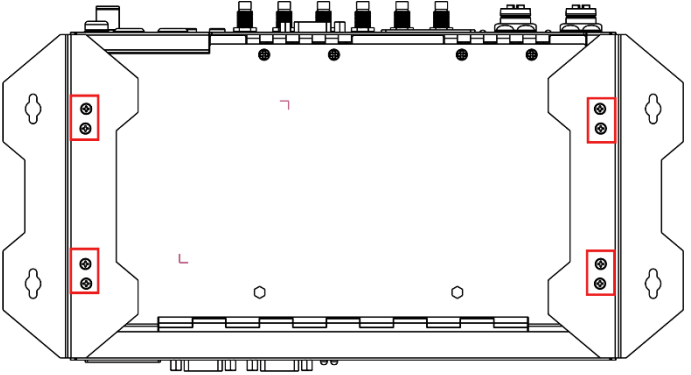

The eight screws for the mounting brackets are included in the product package. They are standard IMS_M3x5L screws and require a torque of 4.5 kgf-cm. Refer to the following illustration for details.

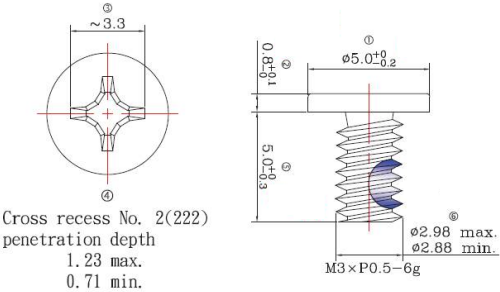

Use two screws (M3*5L standard is recommended) on each side to attach the V2406C to a wall or cabinet. The product package does not include the four screws required for attaching the wall-mounting kit to the wall; they need to be purchased separately. Ensure that the V2406C computer is installed in the direction shown in the following figure.

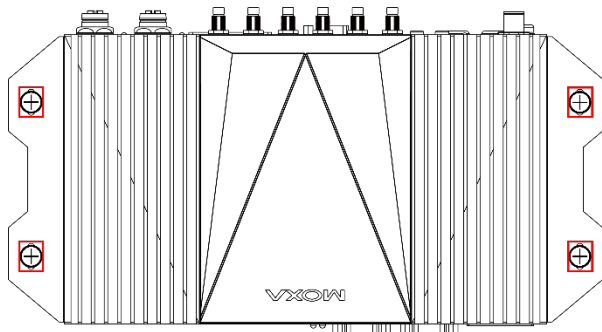

Connecting the Power

The V2406C computers are provided with M12 power input connectors on the front panel. Connect the power cord wires to the connectors and then tighten the connectors. Push the power button; the **Power** LED (on the power button) will light up to indicate that power is being supplied to the computer. It should take about 30 to 60 seconds for the operating system to complete the boot-up process.

Pin	Definition
1	V+
2	N.C.
3	V-
4	N.C.

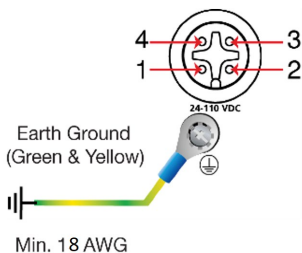

The power input specification is given below:

- DC mains with a power source rating of 24 V @ 2.74 A; 100 V @ 0.584 A, and a minimum of 18 AWG.

For surge protection, connect the grounding connector located below the power connector with the earth (ground) or a metal surface.

Connecting Displays

The V2406C has 1 VGA interface that comes with a D-Sub 15-pin female connector. In addition, another HDMI interface is also provided on the front panel.

NOTE In order to have highly reliable video streaming, use premium, HDMI-certified cables.

USB Ports

The V2406C comes with 2 USB 3.0 ports on the front panel and another 2 USB 3.0 ports on the rear panel. The USB ports can be used to connect to other peripherals, such as keyboard, mouse, or flash drives for expanding the system's storage capacity.

Serial Ports

The V2406C comes with 4 software-selectable RS-232/422/485 serial ports on the rear panel. Port 1 and Port 2 are isolated UART ports. The ports use DB9 male connectors.

Refer to the following table for pin assignments:

Pin	RS-232	RS-422	RS-485 (4-wire)	RS-485 (2-wire)
1	DCD	TxDA(-)	TxDA(-)	-
2	RxD	TxDB(+)	TxDB(+)	-
3	TxD	RxDB(+)	RxDB(+)	DataB(+)
4	DTR	RxDA(-)	RxDA(-)	DataA(-)
5	GND	GND	GND	GND
6	DSR	-	-	-
7	RTS	-	-	-
8	CTS	-	-	-

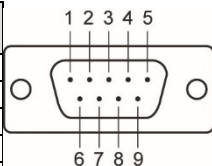

Ethernet Ports

The V2406C has 2 100/1000 Mbps RJ45 Ethernet ports with M12 connectors on the rear panel. Refer to the following table for pin assignments:

Pin	Definition
1	DA+
2	DA-
3	DB+
4	DB-
5	DD+
6	DD-
7	DC-
8	DC+

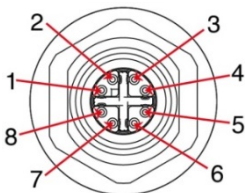

Digital Inputs/Digital Outputs

The V2406C comes with six digital inputs and two digital outputs in a terminal block. Refer to the following figures for the pin definitions and the current ratings.

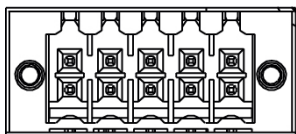
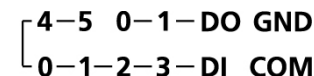

Digital Inputs

Dry Contact
Logic 0: Short to Ground
Logic 1: Open

Wet Contact (DI to COM)
Logic 1: 10 to 30 VDC

Logic 0: 0 to 3 VDC

Digital Outputs

Current Rating:
200 mA per channel

Voltage:
24 to 30 VDC

For detailed wiring methods, refer to the *V2406C Hardware User's Manual*.

Installing Storage Disks

The V2406C comes with two storage sockets, allowing users to install two disks for data storage.

Follow these steps to install a hard disk drive.

1. Unpack the storage tray from the product package.
2. Place the disk drive on the tray.

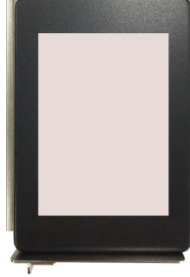

3. Turn the disk and tray arrangement around to view the rear side of the tray. Fasten the four screws to secure the disk to the tray.



4. Unfasten the screw on the storage slot cover and slide the cover down to access the slot.
5. Find the location of the disk tray rail.

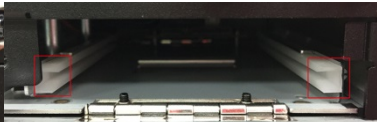

6. Insert the tray so that it aligns with the rails on both sides and slide the tray into the slot.



To take out the tray, simply pull the clutch to the right and pull the tray out.

For instructions on installing other peripheral devices or wireless modules, refer to the *V2406C Hardware User's Manual*.

NOTE This computer is intended to be installed in a restricted access area only. In addition, for safety reasons, the computer should be installed and handled only by qualified and experienced professionals.

NOTE This computer is designed to be supplied by listed equipment rated 24 to 110 VDC, minimum 2.74 to 0.584 A, and minimum $T_{ma}=70^{\circ}\text{C}$. If you need assistance with purchasing a power adapter, contact the Moxa technical support team.

NOTE This unit is intended to be supplied by a DC Busway, output rated 24 to 110 VDC, minimum 2.74 A, and a DC Power source with voltage tolerance of +20% and -15%.
For example, a UL Listed power source suitable for use at a T_{ma} 75°C minimum, rated at 24 to 110 VDC and 2.74 A minimum.

Replacing the Battery

The V2406C comes with one slot for a battery, which is installed with a lithium battery with 3 V/195 mAh specifications. To replace the battery, follow the steps below:

1. The battery cover is located on the front panel of the computer.

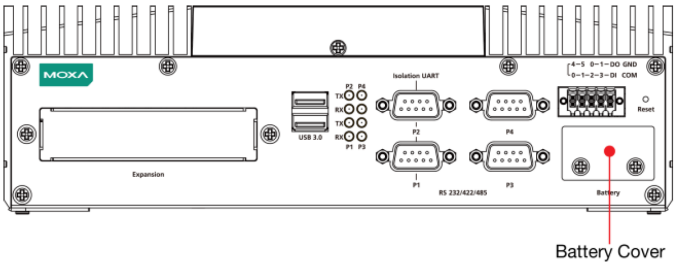

2. Unfasten the two screws on the battery cover.

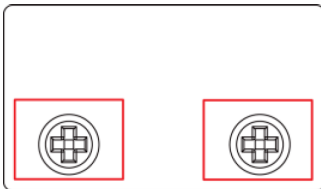

Battery

3. Take off the cover; the battery is attached to the cover.

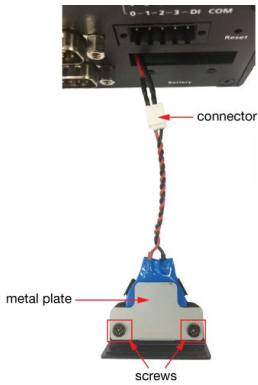

4. Separate the connector and remove the two screws on the metal plate.



5. Replace the new battery in the battery holder, place the metal plate on the battery and fasten the two screws tightly.

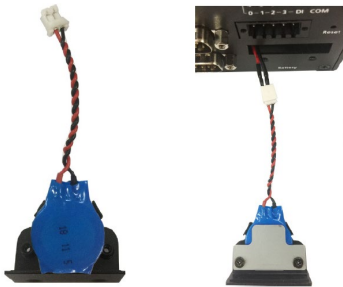

6. Reconnect the connector, place the battery holder into the slot, and secure the cover of the slot by fastening the two screws on the cover

NOTE Be sure to use the correct type of battery. Incorrect battery may cause system damage. Contact Moxa's technical support staff for assistance, if necessary.