

MPC-2150 Panel Computer Hardware User's Manual

Edition 2.1, November 2018

www.moxa.com/product

MOXA[®]

© 2018 Moxa Inc. All rights reserved.

MPC-2150 Panel Computer Hardware User's Manual

The software described in this manual is furnished under a license agreement and may be used only in accordance with the terms of that agreement.

Copyright Notice

© 2018 Moxa Inc. All rights reserved.

Trademarks

The MOXA logo is a registered trademark of Moxa Inc.
All other trademarks or registered marks in this manual belong to their respective manufacturers.

Disclaimer

Information in this document is subject to change without notice and does not represent a commitment on the part of Moxa.

Moxa provides this document as is, without warranty of any kind, either expressed or implied, including, but not limited to, its particular purpose. Moxa reserves the right to make improvements and/or changes to this manual, or to the products and/or the programs described in this manual, at any time.

Information provided in this manual is intended to be accurate and reliable. However, Moxa assumes no responsibility for its use, or for any infringements on the rights of third parties that may result from its use.

This product might include unintentional technical or typographical errors. Changes are periodically made to the information herein to correct such errors, and these changes are incorporated into new editions of the publication.

Technical Support Contact Information

www.moxa.com/support

Moxa Americas

Toll-free: 1-888-669-2872
Tel: +1-714-528-6777
Fax: +1-714-528-6778

Moxa Europe

Tel: +49-89-3 70 03 99-0
Fax: +49-89-3 70 03 99-99

Moxa India

Tel: +91-80-4172-9088
Fax: +91-80-4132-1045

Moxa China (Shanghai office)

Toll-free: 800-820-5036
Tel: +86-21-5258-9955
Fax: +86-21-5258-5505

Moxa Asia-Pacific

Tel: +886-2-8919-1230
Fax: +886-2-8919-1231

Table of Contents

1. Introduction	1-1
Overview	1-2
Ordering Information	1-2
Package Checklist	1-2
Product Features	1-3
MPC-2150 Hardware Specifications	1-3
Hardware Block Diagram	1-5
2. Hardware Introduction	2-1
Appearance	2-2
Front View	2-2
Bottom View	2-2
Dimensions	2-3
SavvyTouch Display Control Buttons	2-3
Real Time Clock	2-4
3. Hardware Connection Description	3-1
Placement Notes	3-2
Panel Mounting	3-3
VESA Mounting	3-4
Wiring Requirements	3-5
Temperature Requirements	3-5
Grounding the MPC-2150 Series	3-5
Powering on/off the MPC-2150 Series	3-6
SavvyTouch Display Control Buttons	3-6
Extending the Displays	3-8
Connecting Data Transmission Cables	3-9
Connecting to a Network	3-9
Connecting to a Serial Device	3-10
Connecting to a Speaker or a Headphone	3-10
Connecting a PS/2 Keyboard and Mouse	3-10
Connecting to USB Devices	3-11
Installing a SATA HDD or SSD	3-11
Installing a CFast Card	3-12
4. Display Resolution	4-1
Installing the VGA Driver	4-2
Adjusting Display Resolution	4-6
5. BIOS Setup	5-1
Entering the BIOS Setup Utility	5-2
Main Information	5-3
Advanced Settings	5-3
Boot Configuration	5-4
HDC Configuration	5-4
Video Configuration	5-5
Chipset Configuration	5-7
Hardware Monitor	5-8
Security Settings	5-8
Set Supervisor Password	5-9
Power Settings	5-9
Boot Settings	5-10
Boot Type	5-10
PXE Boot to LAN	5-10
Add Boot Options	5-10
USB Boot	5-10
EFI Device First	5-11
Boot Delay Time	5-11
Legacy	5-11
Exit Settings	5-12
Exit Saving Changes	5-12
Save Change Without Exit	5-12
Exit Discarding Changes	5-12
Load Optimal Defaults	5-12
Load Custom Defaults	5-12
Save Custom Defaults	5-13
Discard Changes	5-13
Upgrading the BIOS	5-13
6. Display Control Interface	6-1
Connecting to the Console Interface	6-2

Display Control Interface Command Format	6-4
Command Format Description	6-4
Downloading RGB Files	6-6
A. Regulatory Approval Statement	A-1
B. Display Control Interface Commands	B-1
Display Control Interface Commands.....	B-2
BRI (Brightness Minimum Value).....	B-2
BRL (Set LED Brightness of Touch Keypad).....	B-2
BRM (Brightness Maximum Value)	B-2
BRT (User Brightness Control)	B-2
BRU (Glass Display Control-Brightness Button)	B-3
BZZ (Buzzer Control)	B-3
DLN (Download ECDIS RGB Package)	B-3
DL? (ECDIS RGB Package Query)	B-3
ETC (Elapsed Time Counter Query).....	B-4
GMB (Glass Display Control - Minimum Brightness)	B-4
POT (Potentiometer Control).....	B-4
SWI (Scalar Firmware Version Query)	B-4
SWK (Touch Keypad Firmware Version Query)	B-5
ADF (AC Input Power Detect Function).....	B-5
AD? (Query AC Input Power Detect Function Status).....	B-5
BLI (Brightness Control).....	B-5
DUF (Disable UART Command Function).....	B-6
EMS (ECDIS Mode Select)	B-6
C. Configure Serial Interface	C-1
Overview	C-2
Installing the SerialInterface Utility	C-2
Configuring the Serial Interface Mode.....	C-4

1

Introduction

In this chapter, we give a general introduction to the features and specifications of MPC-2150 panel computers.

The following topics are covered in this chapter:

- ❑ **Overview**
- ❑ **Ordering Information**
- ❑ **Package Checklist**
- ❑ **Product Features**
- ❑ **MPC-2150 Hardware Specifications**
- ❑ **Hardware Block Diagram**

Overview

The MPC-2150 15-inch panel computer with 3rd generation Intel® Core™ processor deliver a reliable, durable, high-performance platform of wide versatility for use in industrial environments.

The MPC-2150 series panel computers are designed to operate in a wide -40 to 75°C temperature range and have a patented, fanless, streamlined housing designed for highly efficient heat dissipation, making this one of most reliable industrial platforms available for harsh, hot, outdoor environments like oil and gas fields and drilling platforms.

The MPC-2150 also features a 1,000-nit LCD panel offering a sunlight readable and projected capacitive glove-friendly multi-touch screen, providing an excellent user experience for outdoor applications.

Ordering Information

Available Models

- **MPC-2150X:** 15-inch fanless panel computer with Intel® Celeron® 1047UE 1.4 GHz processor, RS-232/422/485 serial ports, Gigabit LAN ports, USB 2.0 ports, 2.5" SSD tray and CFast slot, dual AC/DC power inputs, tape bonding, -40 to 70°C operating temperature
- **MPC-2150Z:** 15-inch fanless panel computer with Intel® Celeron® 1047UE 1.4 GHz processor, RS-232/422/485 serial ports, Gigabit LAN ports, USB 2.0 ports, 2.5" SSD tray and CFast slot, dual AC/DC power inputs, tape bonding, projected capacitive touch screen, -40 to 70°C operating temperature
- **MPC-2157X:** 15-inch fanless panel computer with Intel® Core™ i7 3517UE 1.7 GHz processor, RS-232/422/485 serial ports, Gigabit LAN ports, USB 2.0 ports, 2.5" SSD tray and CFast slot, dual AC/DC power inputs, tape bonding, -40 to 70°C operating temperature
- **MPC-2157Z:** 15-inch fanless panel computer with Intel® Core™ i7 3517UE 1.7 GHz processor, RS-232/422/485 serial ports, Gigabit LAN ports, USB 2.0 ports, 2.5" SSD tray and CFast slot, dual AC/DC power inputs, tape bonding, projected capacitive touch screen, -40 to 70°C operating temperature

Optional Accessories (can be purchased separately)

- **MPC-MD-2-15-PMTK:** 8 screws for panel mount
- **MPC-MD-2-15-VESAMTK:** VESA mounting bracket, 100x100mm and 75x75mm

Package Checklist

The MPC-2150 panel computer is shipped with the following items:

- MPC-2150 panel computer
- 1 2-pin terminal block for DC power input
- SSD installation kit
- Documentation and driver DVD
- Quick installation guide (printed)
- Warranty card

NOTE Notify your sales representative if any of the above items are missing or damaged.

Product Features

The MPC-2150 series panel computer has the following features:

- 15-inch panel computer
- 3rd Generation Intel® processor (Celeron® 1047UE, 1.40 GHz, or Intel® Core i7 3517UE 1.7 GHz)
- -40 to 70°C wide temperature design
- 1,000-nit sunlight readable LCD
- Glove-friendly multi-touch
- Fanless system design
- Multiple power supplies (AC & DC)

MPC-2150 Hardware Specifications

Computer

CPU:

Intel® Core™ i7-3517UE 1.7 GHz, or

Intel® Celeron® 1047UE 1.4 GHz

Supported OS: Windows Embedded Standard 7 32/64-bit, Windows 7 Professional 32/64-bit (the OS is not pre-installed)

System Chipset: Intel® HM65 Express Chipset

System Memory: 4 GB pre-installed (1 slot for a 4 GB DDR3-1066 204-pin SO-DIMM SDRAM)

USB: USB 2.0 hosts x 4, type A connectors, supporting system boot up

Storage: 1 2.5" HDD/SSD slot + 1 CFast slot (storage is not pre-installed)

BIOS: 64 Mbit Flash BIOS SPI type, ACPI function supported

Video Output: DVI-D x 1, VGA x 1 (female)

Buzzer: 75 to 85 db (IEC 60945 compliant)

Other Peripherals

Audio: Line-in and line-out interface, with 3.5 mm mini jack

KB/MS: 2 PS/2 interface supporting standard PS/2 keyboard and mouse

Display

Panel Size: 15-inch viewable image size

Panel Type: TN

Touch: Capacitive multi-touch with glove-friendly support (optional)

Aspect Ratio: 5:4

Pixels: 1024 x 768

Pixel Pitch (RGB): 0.297 (H) x 0.297 (V) mm

Response Time: 20 ms (gray to gray)

Contrast Ratio: 700:1

Light Intensity: 1000 cd/m²

Active Display Area: 304.128 (H) x 228.096 (V) mm

Ethernet Interface

LAN: 2 auto-sensing 10/100/1000 Mbps ports (RJ45)

Magnetic Isolation Protection: 1.5 kV built-in

Serial Interface

Serial Standards: 2 RS-232/422/485 ports, software-selectable (DB9 male)

Serial Communication Parameters

Data Bits: 5, 6, 7, 8

Stop Bits: 1, 1.5, 2

Parity: None, Even, Odd, Space, Mark

Flow Control: RTS/CTS, XON/XOFF, ADDC® (automatic data direction control) for RS-485

Baudrate: 50 bps to 115.2 Kbps

Serial Signals

RS-232: TxD, RxD, DTR, DSR, RTS, CTS, DCD, GND

RS-422: TxD+, TxD-, RxD+, RxD-, GND

RS-485-4w: TxD+, TxD-, RxD+, RxD-, GND

RS-485-2w: Data+, Data-, GND

LEDs

System: Storage, Power

LAN: 100M/Link x 2, 1000M/Link x 2 (on connector)

Physical Characteristics

Housing: Aluminum sheet metal

Weight: 6.5 kg

Dimensions: 356 x 315 x 77.2 mm (14.02 x 12.40 x 3.04 in)

Mounting: Panel and VESA mounting (mounting kit is optional)

System Cooling: Fanless thermal design

Environmental Limits

Operating Temperature: -40 to 70°C (-40 to 158°F)

Storage Temperature: -40 to 70°C (-40 to 158°F)

Ambient Relative Humidity: 5 to 95% (non-condensing)

Anti-Vibration: 2 g rms, 5-500 Hz frequency, compliant with IEC 60068-2-6 standard

Anti-shock: 20 g rms, half sine wave under system operating, 11 ms duration, compliant with IEC 60068-2-27 standard

Power Requirements

Input Voltage:

- DC: 12/24 VDC (Range 9 to 36 VDC)
- AC: 100 to 240 VAC

Power Consumption: Less than 120 W, 2.5 A @ 24 VDC

Standards and Certifications

Safety: UL 60950-1, IEC 60950-1

EMC: EN 55032/24

EMI: CISPR 32, FCC Part 15B Class A

EMS:

- IEC 61000-4-2 ESD: Contact 4 kV; Air 8 kV
- IEC 61000-4-3 RS: 10 V/m (80 MHz to 1 GHz)
- IEC 61000-4-4 EFT: Power 2 kV; Signal 1 kV
- IEC 61000-4-5 Surge: Power 2 kV; Signal 1 kV
- IEC 61000-4-6 CS: 10 V
- IEC 61000-4-8, IEC 61000-4-11

Ingress Protection Rating: IP66 (front) / IP22 (rear) / NEMA 4X

Green Product: RoHS, cRoHS, WEEE

Warranty

Warranty Period:

- Computer system: 3 years
- LCD panel: 1 year

Details: See www.moxa.com/warranty

Hardware Block Diagram

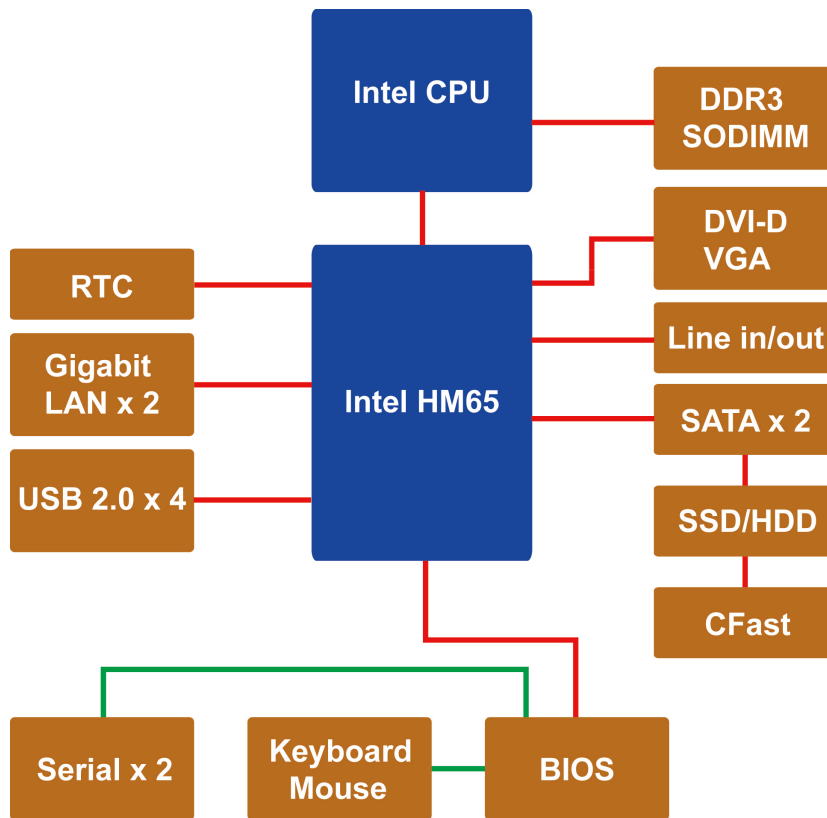

Hardware Introduction

The MPC-2150 Series computer is compact, well-designed, and ruggedized for industrial applications. The intelligent SavvyTouch display control buttons allow you to indicate control buttons easily in low light environment and identify system hardware failure easily. Multiple serial ports allow you to connect different devices for data operation, and the reliable and stable hardware platform lets you devote your attention to developing your applications.

The following topics are covered in this chapter:

- ❑ **Appearance**
 - Front View
 - Bottom View
- ❑ **Dimensions**
- ❑ **SavvyTouch Display Control Buttons**
- ❑ **Real Time Clock**

Appearance

Front View

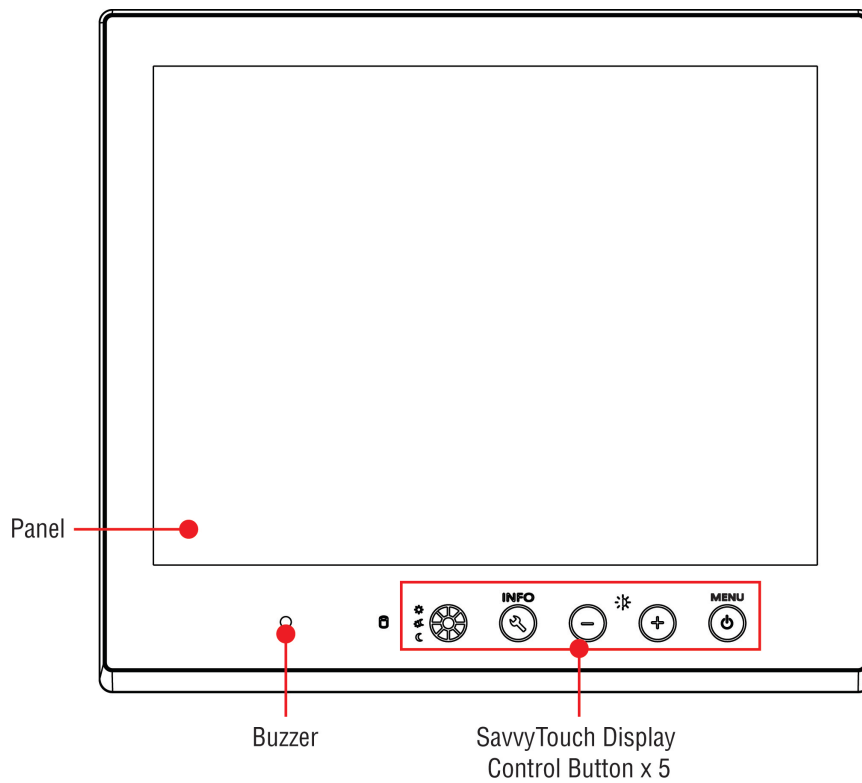

Bottom View

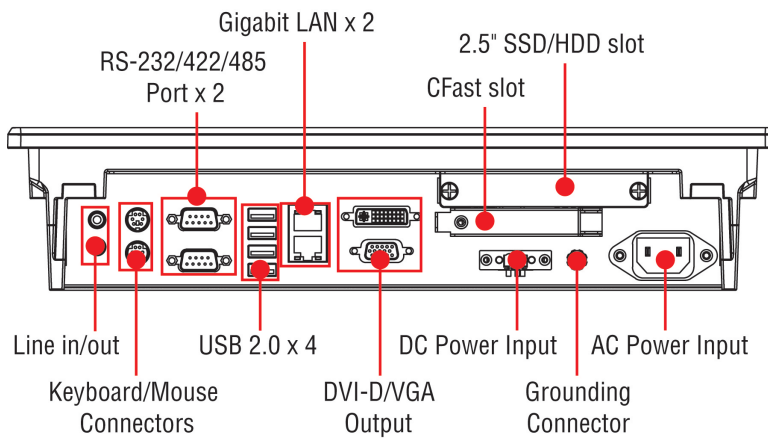



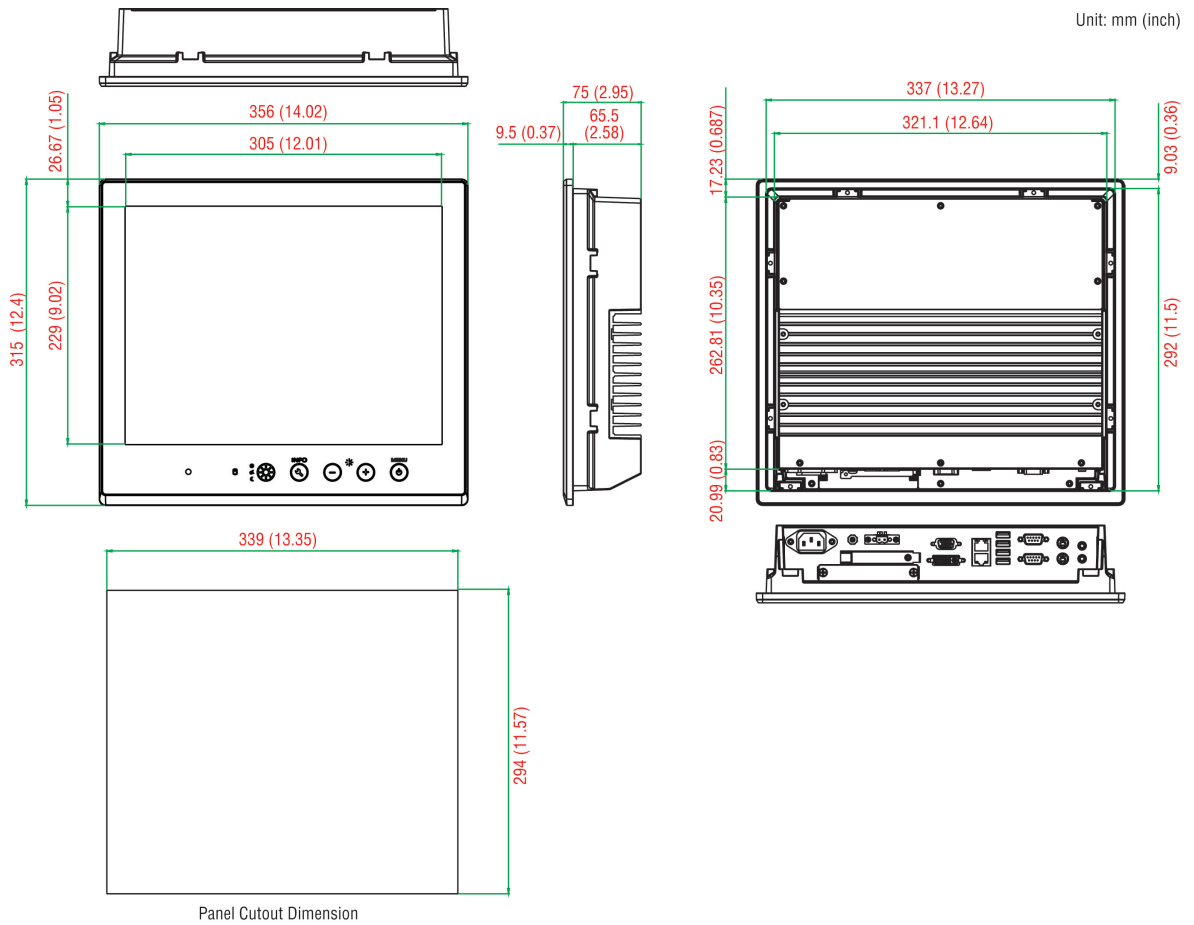

Dimensions



SavvyTouch Display Control Buttons

The MPC-2150 comes with SavvyTouch display control buttons located at the lower right corner of the front surface. These intelligent buttons will light up automatically when your fingers draw near. Refer to the following table for the function of each button.

Name	Displayed Color	Control Function / Color Legend
 Power	Green	Computer is powered on and functioning normally
	Red	Power standby and system shut down
	Off	Power is off.
 Brightness	White	+ : To increase brightness of panel - : To decrease brightness of panel
 Info	Off	System functioning normally
	Red	System hardware error
 Storage	Red (on)	Storage drive is functioning properly
	Red (blinking)	Drive is accessing or writing data
	Off	Drive is offline.
 Display mode	White	Displays the brightness mode
	Off	Panel brightness out of ECDIS standard range

Real Time Clock

The computer's real-time clock is powered by a lithium battery. We strongly recommend that you **NOT** replace the lithium battery on your own. If the battery needs to be changed, please contact the Moxa RMA service team.



ATTENTION

There is a risk of explosion if the wrong type of battery is used. To avoid this potential danger, always be sure to use the correct type of battery. Contact the Moxa RMA service team if you need to replace your battery.

Hardware Connection Description

In this chapter, we show how to connect the panel computer to the network and to various devices.

The following topics are covered in this chapter:

- ❑ **Placement Notes**
 - Panel Mounting
 - VESA Mounting
- ❑ **Wiring Requirements**
- ❑ **Temperature Requirements**
- ❑ **Grounding the MPC-2150 Series**
- ❑ **Powering on/off the MPC-2150 Series**
 - SavvyTouch Display Control Buttons
- ❑ **Extending the Displays**
- ❑ **Connecting Data Transmission Cables**
 - Connecting to a Network
 - Connecting to a Serial Device
- ❑ **Connecting to a Speaker or a Headphone**
- ❑ **Connecting a PS/2 Keyboard and Mouse**
- ❑ **Connecting to USB Devices**
- ❑ **Installing a SATA HDD or SSD**
- ❑ **Installing a CFast Card**

Placement Notes

Before installing and mounting the MPC-2150 panel computer, please read the following notes:

1. The MPC-2150 series is designed for various installation or mounting methods, for example: wall mounting, and VESA mounting. Please refer to the relevant mechanical drawings in the next sections before attempting to mount the panel.
2. It is advised that good ventilation is necessary to prolong the computer's lifespan. The chassis' heat-sink area **MUST** be kept clear from other heat generating items, as this may damage the system motherboard. The minimal distance is 150 mm.
3. Allow sufficient physical space for proper ventilation, cable connectors, wiring passage, and practical maintenance purposes.
4. **DO NOT** install the unit in a horizontal position (laying down), as the heat inside of the unit is not dissipated effectively and will damage the LCD panel. It is recommended to install the unit in a vertical position (± 30 degrees) for better heat dissipation.
5. Exposure to extreme direct sunlight may cause a considerable increase in the temperature of the unit, and under certain circumstances might lead to overheating. Please take this point into consideration when the bridge equipment is being planned (sun shades, distance from the windows, ventilation, etc.)
6. Exposure to strong vibration or acoustic noise might affect the functionality and expected lifetime of the computer. Take consideration of these factors during system assembly and installation, to ensure the mounting position avoids exposure to strong vibrations.
7. For maximum safety, at least two persons should work together to lift, place, and fasten the computer to its mounting point. Before you lift or move the computer, first verify the computer is disconnected from any power source, and turned off. In addition, make sure you have prepared the correct screws for a wall mounting.

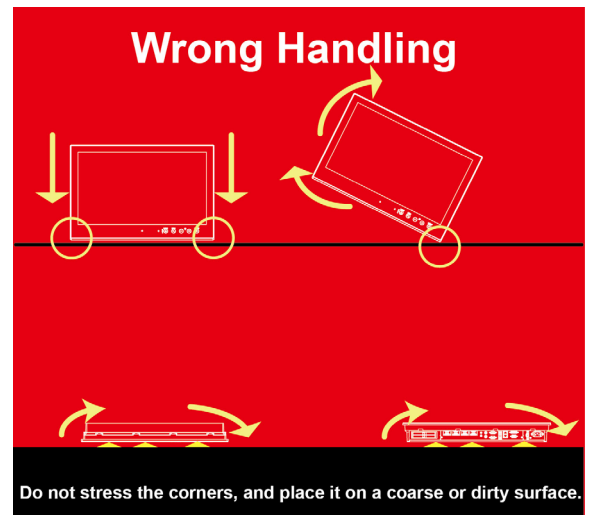
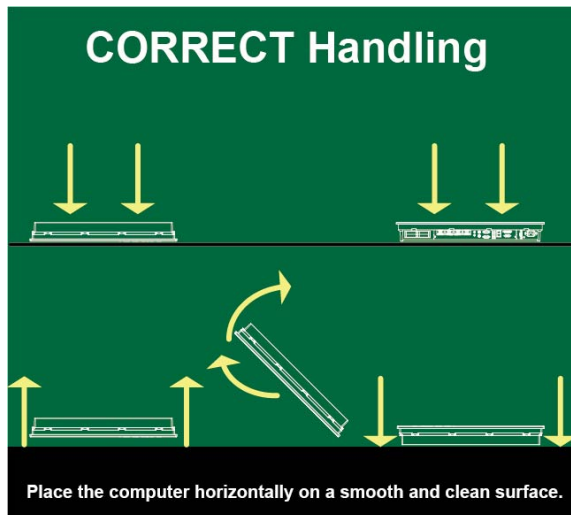

Panel Mounting

The MPC-2150 Series comes with 8 optional clamp mounts that allow for installation onto a wall (where space has been cut out to accommodate the rest of the hardware) or into computing stations where a flush mount is desired. **The maximum thickness of the surface to which the computer will be clamped is 11 mm.** For a secure mounting, all 8 clamps must be used. The clamp arms are fastened into slots on all four sides of the MPC-2150. Use the short M4 SUS (stainless) screws to fasten the clamp arms to the MPC-2150 mounting slots, as shown in the magnified inset in the diagram below. Next, use the clamps to fasten the computer to its mounting point; please note the torque value that is shown in the figure inset below.

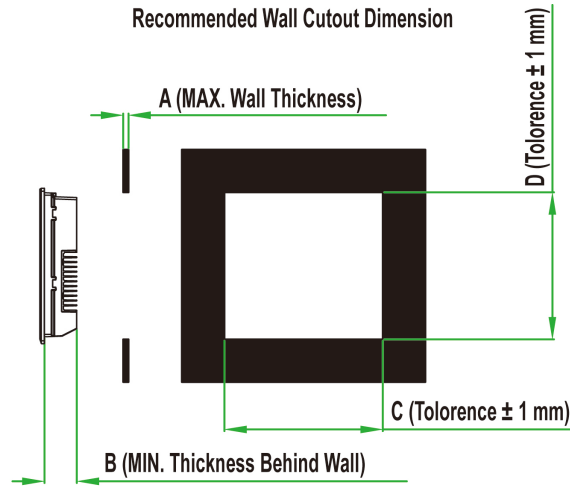

A	B	C	D	Mounting Kits (pcs)
8.0 mm	65.0 mm	339.0 mm	294.0 mm	8

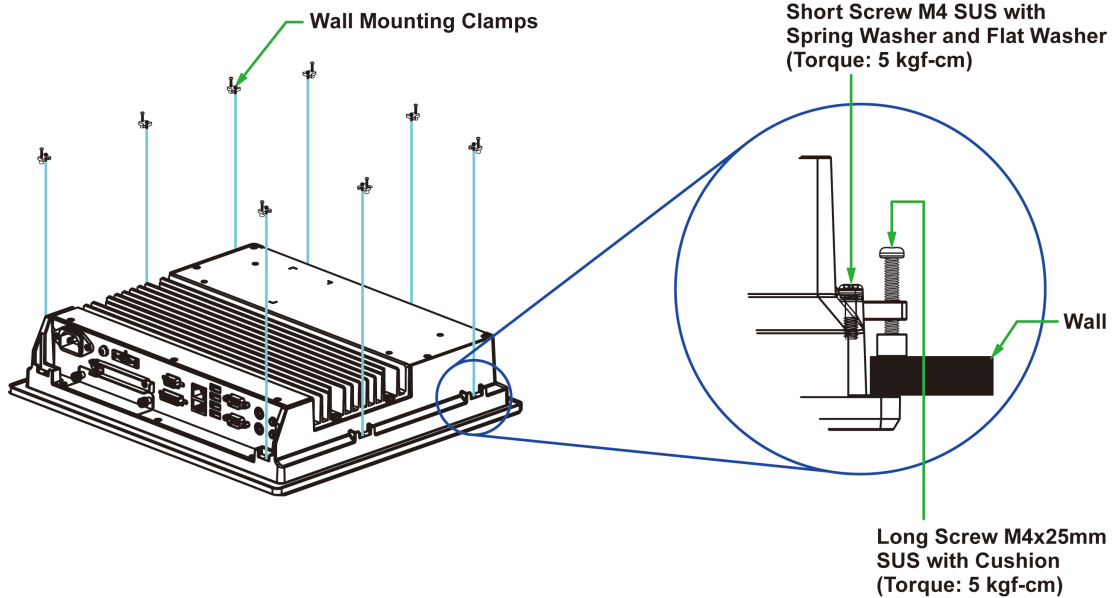

VESA Mounting

The MPC-2150 also comes with an optional VESA mounting kit. Four round screws are required to fasten the VESA mounting bracket. See the figure below for detailed screw specifications and torque values.

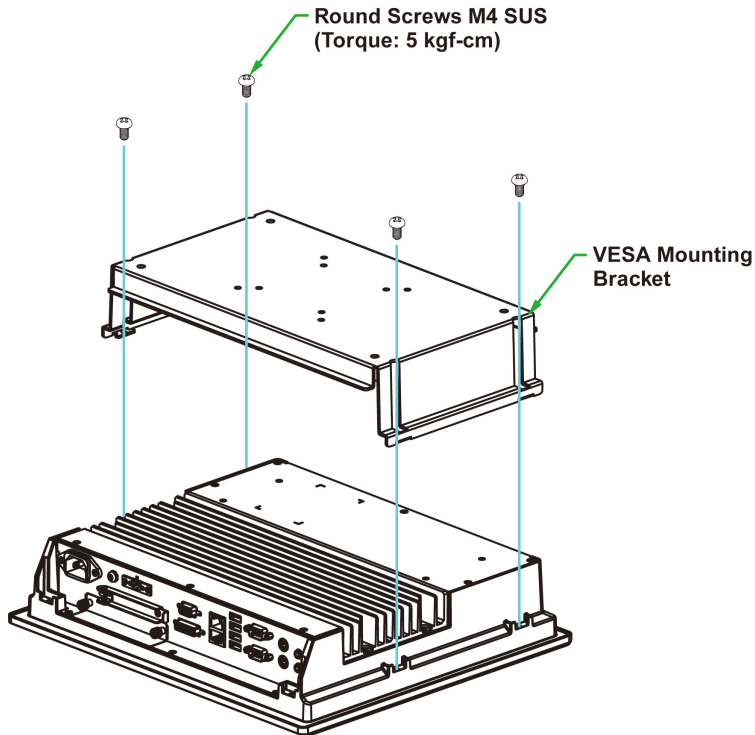

An additional four screws (not included in the kit) are required to mount the computer on a VESA rack. For this purpose, use M6 screws with a length between 10 and 12 mm.

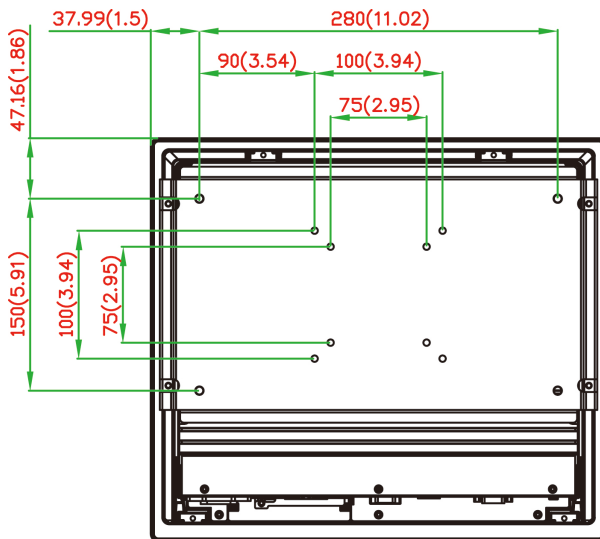

VESA Mounting Kit
 4-M6 10 to 12 mm deep mounting holes (280 x 150 mm)
 8-M4 10 to 12 mm deep mounting holes (100 x 100 mm / 75 x 75 mm)

Wiring Requirements

This section describes how to connect peripheral devices to the panel computer.

You should read and follow these common safety precautions before proceeding with the installation of any electronic device:

- Use separate paths to route wiring for power and devices. If power wiring and device wiring paths must cross, make sure the wires are perpendicular at the intersection point.

NOTE Do not run signal or communication wiring together with power wiring in the same wire conduit. To avoid interference, wires with different signal characteristics should be routed separately.

- Use the type of signal transmitted through a wire to determine which wires should be kept separate. The rule of thumb is that wiring that shares similar electrical characteristics can be bundled together.
- Keep input wiring and output wiring separate.
- It is advisable to label the wiring to all devices in the system.



ATTENTION

Safety First!

Be sure to disconnect the power cord before installing and/or wiring your MPC-2150 Series.

Wiring Caution!

Calculate the maximum possible current in each power wire and common wire. Observe all electrical codes dictating the maximum current allowable for each wire size.

If the current goes above the maximum ratings, the wiring could overheat, causing serious damage to your equipment.

Temperature Requirements

Be careful when handling the unit. When the unit is plugged in, the internal components generate heat, and consequently the outer casing may feel hot to the touch.

We recommend taking the following precautions to minimize heat build-up within the display:

- Position the display within $\pm 40^\circ$ of the vertical.
- Install an external fan to increase airflow upwards through the display if (a) the display is not positioned within $\pm 40^\circ$ of the vertical, (b) the ambient temperature exceeds 25°C , or (c) the display is used in a location with minimal ventilation.

Grounding the MPC-2150 Series

Before you power on the MPC-2150 Series, please ground the MPC-2150 as grounding and wire routing help limit the effects of noise due to electromagnetic interference (EMI). Run the ground connection from the ground screw to the grounding surface prior to connecting the power.



ATTENTION

This product is intended to be mounted to a well-grounded mounting surface, such as a metal panel.

Grounding: See the figure shown below for the location of the grounding connector. Connect the grounding wire to an appropriate grounded metal surface.

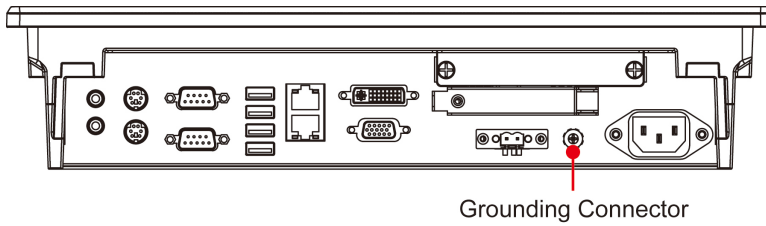

Powering on/off the MPC-2150 Series

The MPC-2150 allows using either an AC or DC power input. When using AC power, use the standard C14 AC inlet. When using DC power, use at least a 60 W power adapter through the 2-pin terminal block in the accessories package. The figure shows the MPC-2150's DC pin assignments. Touch the **MENU** button (in the lower right corner of the display panel) for 1 second to turn on the computer. It takes about 10 to 30 seconds for the system to boot up.

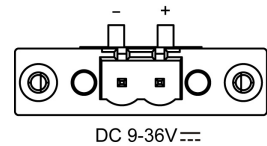

To power off the MPC-2150 Series, press the **MENU** button (mentioned above) for 1 second; depending on your OS's power management settings you may enter **standby**, **hibernation**, or **system shutdown** mode. If you hold the power button for more than 5 seconds, the system will be forced to hard shutdown.

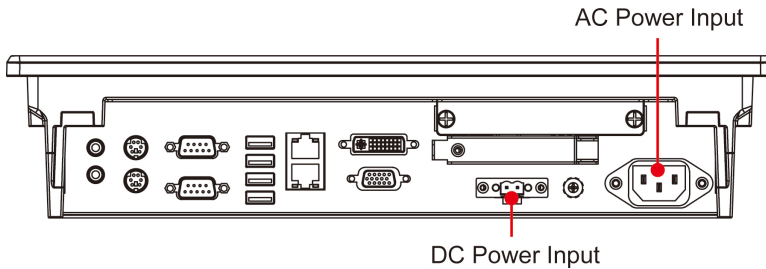

SavvyTouch Display Control Buttons

The MPC-2150 Series comes with five SavvyTouch display control buttons located on the front surface. These intelligent controls will light up when you move your hand over the area of the screen where they are located.

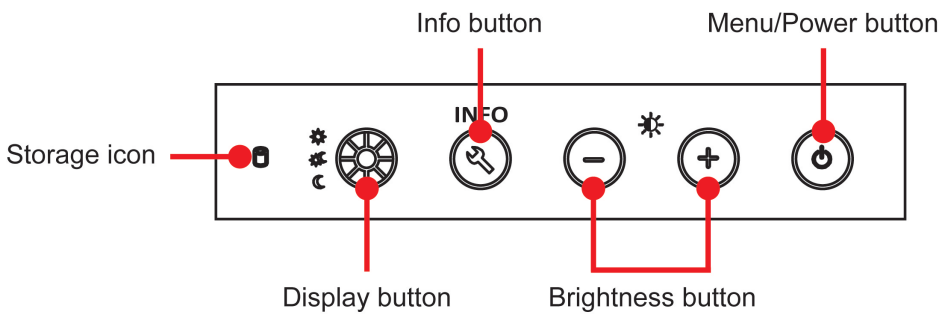

MENU

The **MENU** button operates like a power button, with which users may start up or shut down the computer. Holding the button for 1 second will power on the system, and the button will light up a solid green. To power off the MPC-2150, press and hold the **Menu** button for 4 seconds to enter **standby**, **hibernation**, or **system shutdown** mode, depending on the power management settings you have set in your operating system. If a hard shutdown is required because of technical problems, press and hold the **Menu** button for 10 seconds to forcibly power off the system.

Brightness

Two brightness buttons are available for brightness control. Press the **+** button to increase the brightness of the panel, and the **-** button to decrease the brightness.

INFO

The **INFO** button returns the current system status for various components, such as power for AC input and main board, CPU, memory, chipset and VGA output. **Pass** will indicate that the subsystem is working well. An error message will be shown when the system is not working. CPU, memory, chipset and VGA output will be detected only at the bootup stage; any changes or failures that occur after that will not be registered by the system. The AC power and mainboard power (Main Board Power) options will be continuously detected, even after the computer has been booted up.

System Status	
AC Input Power	Pass
M / B Power	Pass
CPU	Pass
Memory	Pass
Chipset	Pass
VGA	Pass



(Brightness Mode)

Touch the button to switch between **DAY**, **DUSK**, and **NIGHT** display modes.



(Storage)

A storage icon can also be found on the panel. When data access occurs, it will display a blinking red status.

NOTE The display of the MPC-2150 can also be controlled with a series of commands. For a list of the available commands and their uses, refer to **Appendix B: Display Control Interface Commands** for details

Extending the Displays

The MPC-2150 comes with both standard VGA (DB15) and DVI-D (DB24) interfaces on the bottom surface. They may be used simultaneously to extend the display across two monitors. See the following figures and tables for the location and pin assignments for the display outputs.

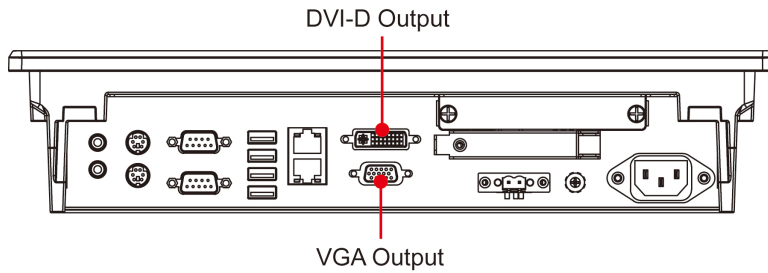

DB15 Female Connector

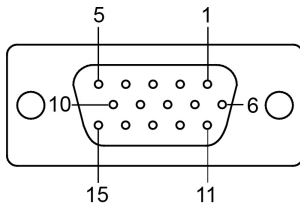

Pin No.	Signal Definition
1	Red
2	Green
3	Blue
4	NC
5	GND
6	GND
7	GND
8	GND

Pin No.	Signal Definition
9	VCC
10	GND
11	NC
12	DDC2B Data
13	HSYNC
14	VSYSN
15	DDC2B Clock

DVI-D Connector

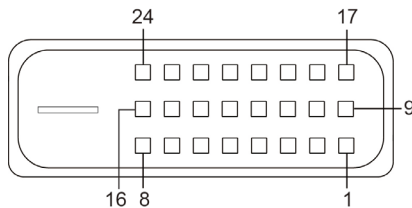

Pin	Signal Definition	Pin	Signal Definition
1	T.M.D.S. Data2-	13	N/C
2	T.M.D.S. Data2+	14	+5V Power
3	T.M.D.S. Data2 Shield	15	Ground (return for +5V, HSync, and VSync)
4	N/C	16	Hot Plug Detect
5	N/C	17	T.M.D.S. Data0-
6	DDC Clock	18	T.M.D.S. Data0+
7	DDC Data	19	T.M.D.S. Data0 Shield
8	N/C	20	N/C
9	T.M.D.S. Data1-	21	N/C
10	T.M.D.S. Data1+	22	T.M.D.S. Clock Shield
11	T.M.D.S. Data1 Shield	23	T.M.D.S. Clock+
12	N/C	24	T.M.D.S. Clock-

NOTE VGA interface uses analog signals, which may be affected by the quality of the VGA cable; we recommend using the DVI-D interface to extend your display.

Connecting Data Transmission Cables

This section describes how to connect the MPC-2150 panel computer to a network, or serial devices.

Connecting to a Network

Plug an Ethernet cable into the MPC-2150's Ethernet port. The other end of the cable should be plugged into your Ethernet network. When the cable is properly connected, the LEDs on the panel computer's Ethernet port will glow to indicate a valid connection. See the following figure for the location of the Ethernet ports.

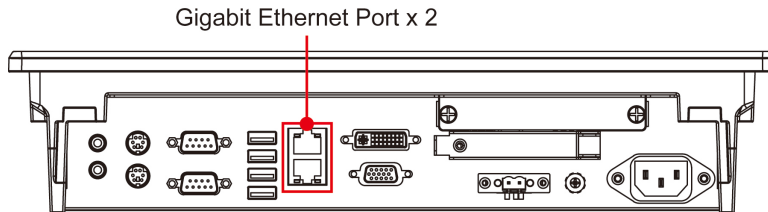

The 10/100/1000 Mbps Ethernet LAN port uses 8-pin RJ45 connectors. The following diagram shows the pinouts and the descriptions for these ports.

LAN (on connectors)	Green	100 Mbps Ethernet mode
	Yellow	1000 Mbps (Gigabit) Ethernet mode
	Off	No activity or 10 Mbps Ethernet mode

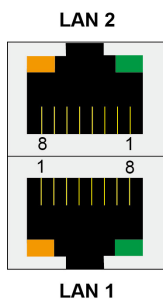

Pin	100 Mbps	1000 Mbps
1	ETx+	TRD(0)+
2	ETx-	TRD(0)-
3	ERx+	TRD(1)+
4	-	TRD(2)+
5	-	TRD(2)-
6	ERx-	TRD(1)-
7	-	TRD(3)+
8	-	TRD(3)-

Connecting to a Serial Device

Use a serial cable to plug your serial device into the MPC-2150's serial port. Serial ports 1 and 2 have male DB9 connectors and can be configured for RS-232, RS-422, or RS-485 communication by software. See the following figure for the location of the serial ports.

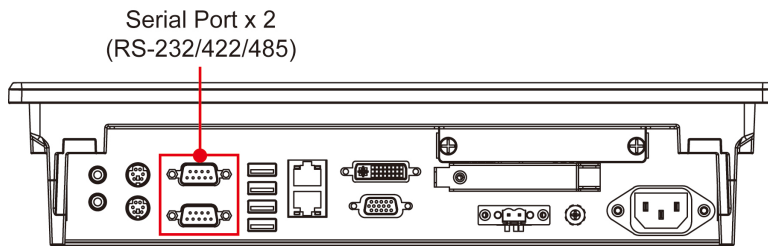

The pin assignments are shown in the table at the top of the next page:

DB9 Male Port

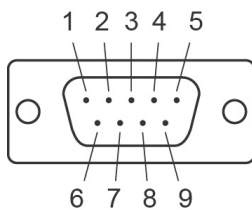

RS-232/422/485 Pinouts

Pin	RS-232	RS-422	RS-485 (4-wire)	RS-485 (2-wire)
1	DCD	TxDA(-)	TxDA(-)	-
2	RxD	TxDB(+)	TxDB(+)	-
3	TxD	RxDB(+)	RxDB(+)	DataB(+)
4	DTR	RxDA(-)	RxDA(-)	DataA(-)
5	GND	GND	GND	GND
6	DSR	-	-	-
7	RTS	-	-	-
8	CTS	-	-	-

Connecting to a Speaker or a Headphone

The MPC-2150 comes with line-in and line-out interfaces for connecting a microphone and either speakers or headphones. See the following figure for the location.

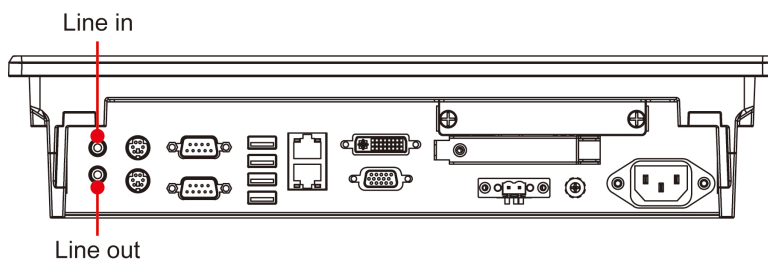

Connecting a PS/2 Keyboard and Mouse

Your MPC-2150 computer comes with two PS/2 connectors to connect to a PS/2 keyboard (upper connector) and PS/2 mouse (lower connector). See the following figure for the locations.

PS/2 Keyboard Connector

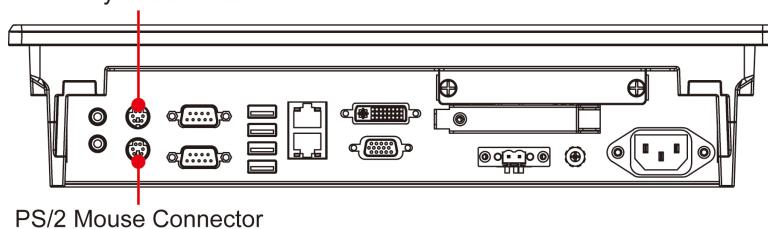

Connecting to USB Devices

The MPC-2150 comes with 4 USB 2.0 ports on the computer. The ports can be used for an external flash disk or hard drive for data storage expansion. You can also use these USB ports to connect to a keyboard or a mouse.

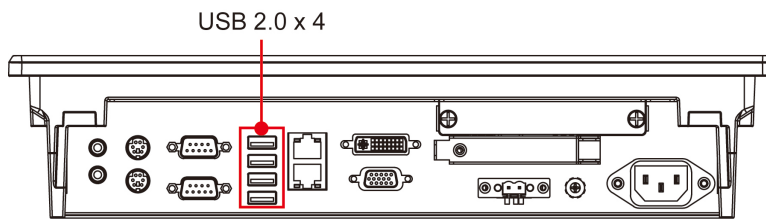

Installing a SATA HDD or SSD

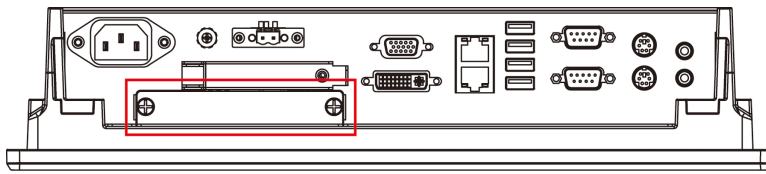

The MPC-2150 comes with an HDD/SSD installation kit accessory. To install the 2.5-inch SATA storage, follow these instructions. For better system reliability, we suggest using a solid state disk (SSD). A list of compatible SSD models is available on Moxa's website.

1. Use 4 screws to fasten the HDD/SSD to the HDD/SSD bracket.

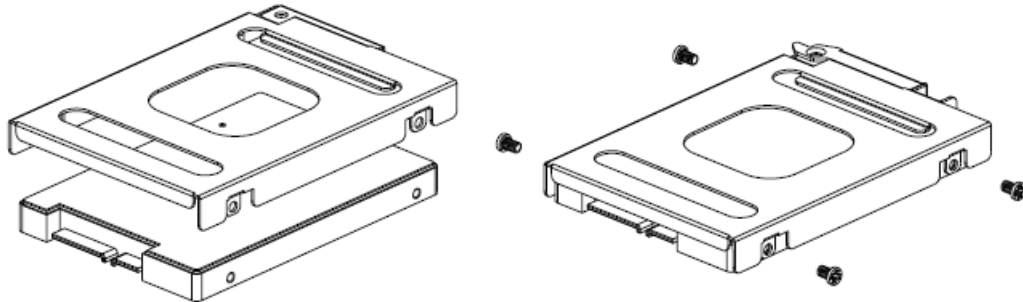

2. Remove the 2 screws holding the HDD/SSD cover to the MPC-2150.

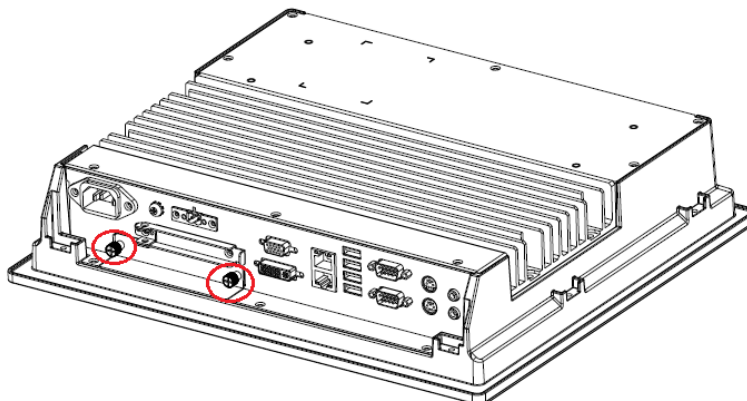

3. Insert the HDD/SSD (with the bracket) into the HDD/SDD slot. Noted that the latch on HDD/SSD bracket should be released when pushing the HDD/SSD into the slot.

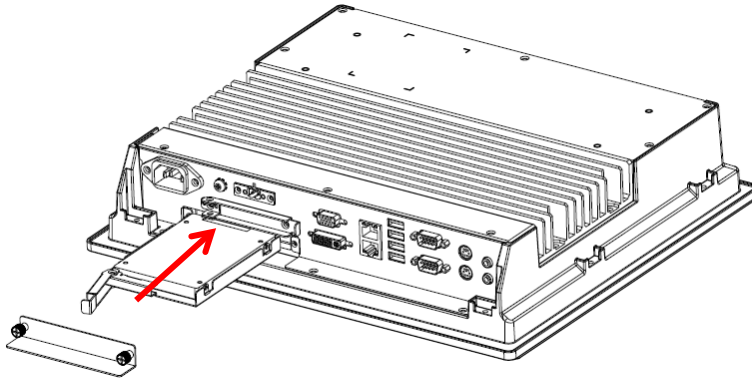

4. Reattach the HDD/SSD cover and fix it to the front panel with the 2 screws.

Installing a CFast Card

The MPC-2150 has a CFast slot that can be used to install a standard CFast card using a push-push mechanism. A list of compatible CFast cards can be found on Moxa's website.

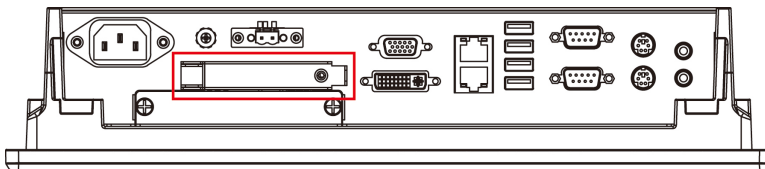

1. Loosen the screws connecting the HDD/SSD cover to the MPC-2150.

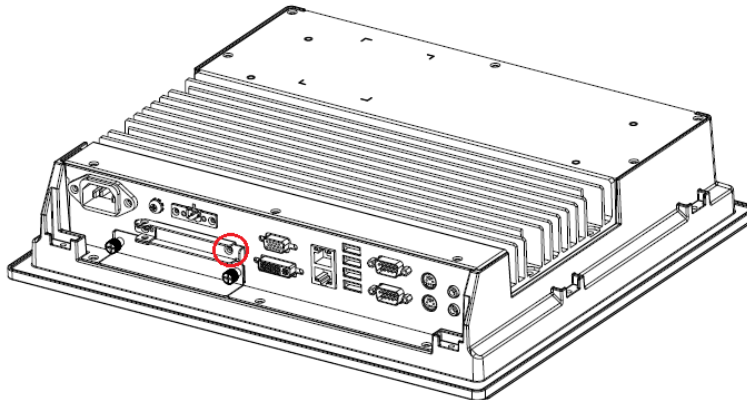

2. Insert the CFast card into the slot using the push-push mechanism.

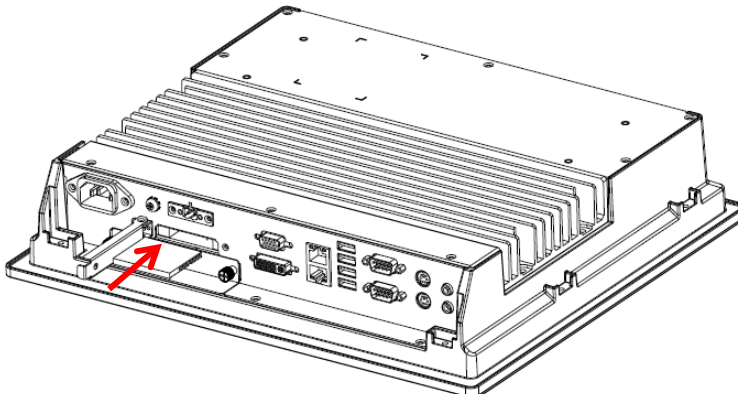

3. Reattach the CFast cover.

Display Resolution

This chapter describes how to install the VGA driver. After installing the drivers, you may use the tools described below to adjust the display resolution of your panel computer.

The following topics are covered in this chapter:

- ❑ **Installing the VGA Driver**
- ❑ **Adjusting Display Resolution**

Installing the VGA Driver

The MPC-2150 comes with a stock VGA driver for Windows Embedded Standard 7. Follow these steps to install.

1. On the product CD go to the **Driver** folder and select **Win7**. Select either **32-bit** or **64-bit**, according to your platform, then select **2.VGA** folder.

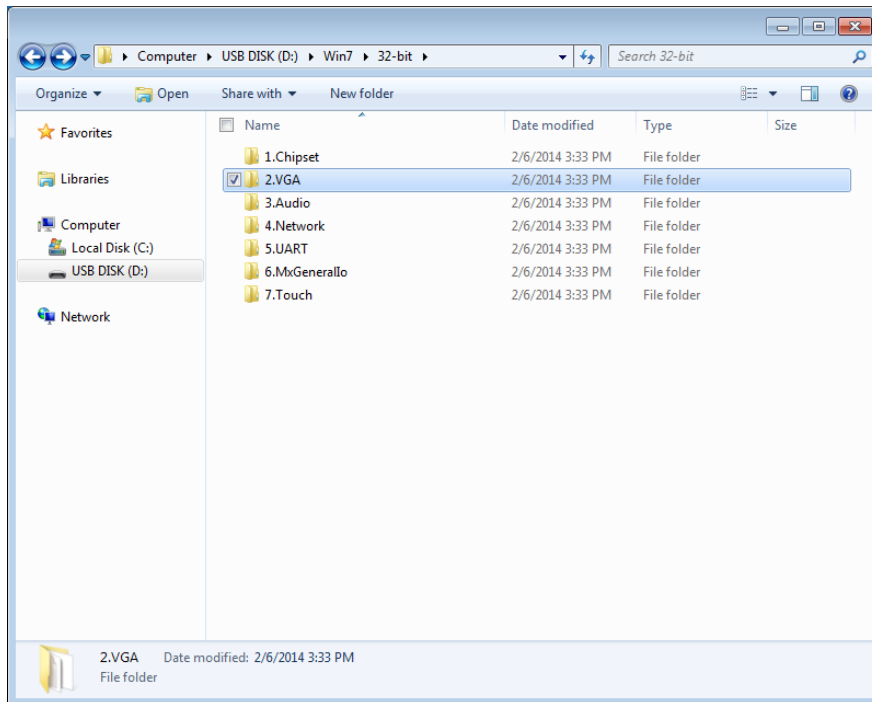

2. Double-click **Win32_15319** to continue.

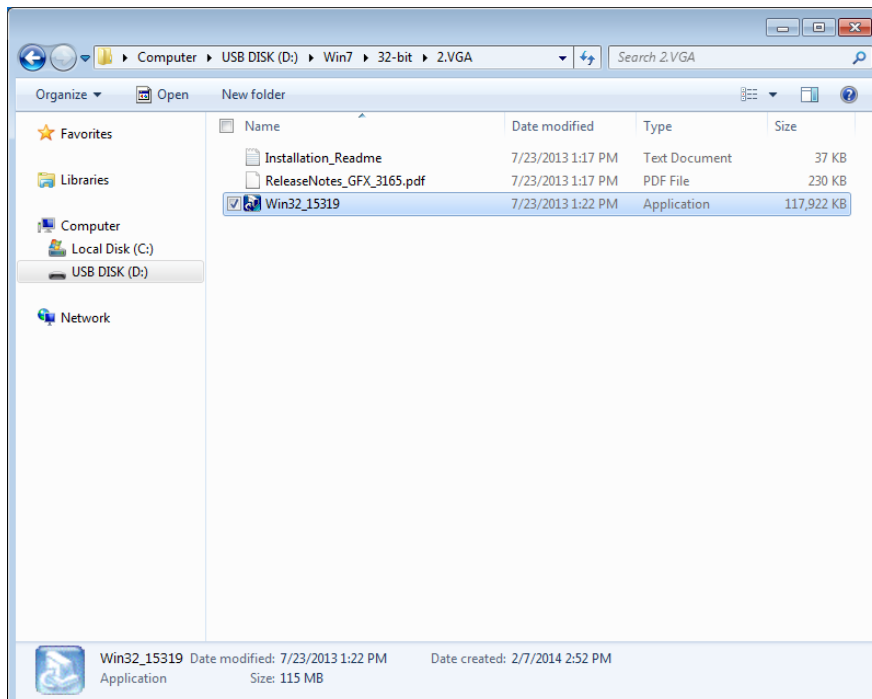

- The installation wizard will be launched; click **Next** to continue.

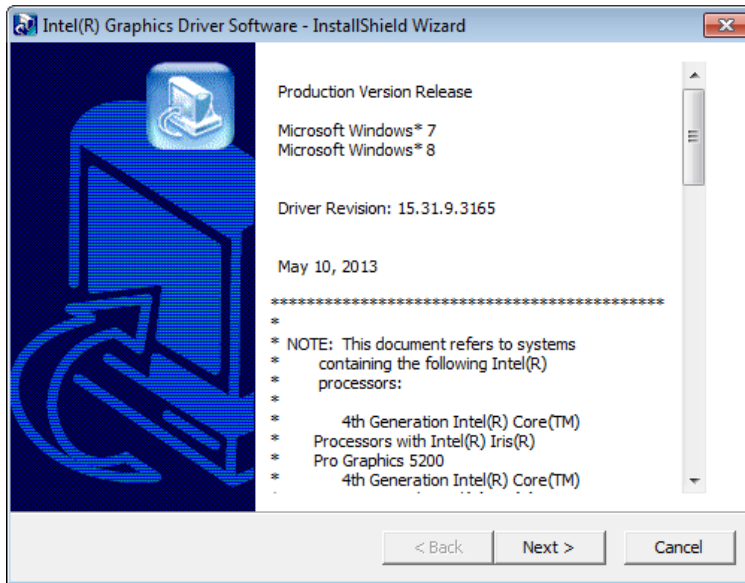

- Click **Next** to start the installation.



- Click **Yes** to accept the license agreement.

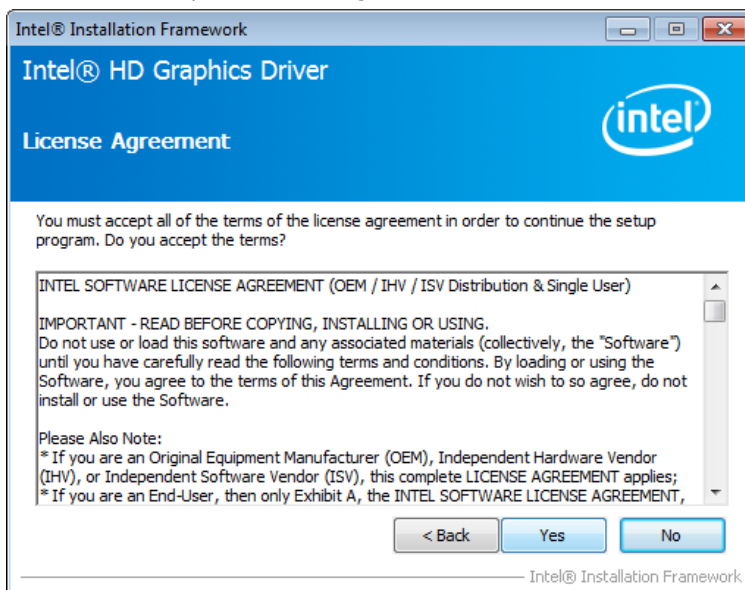

6. Click **Next** to continue.

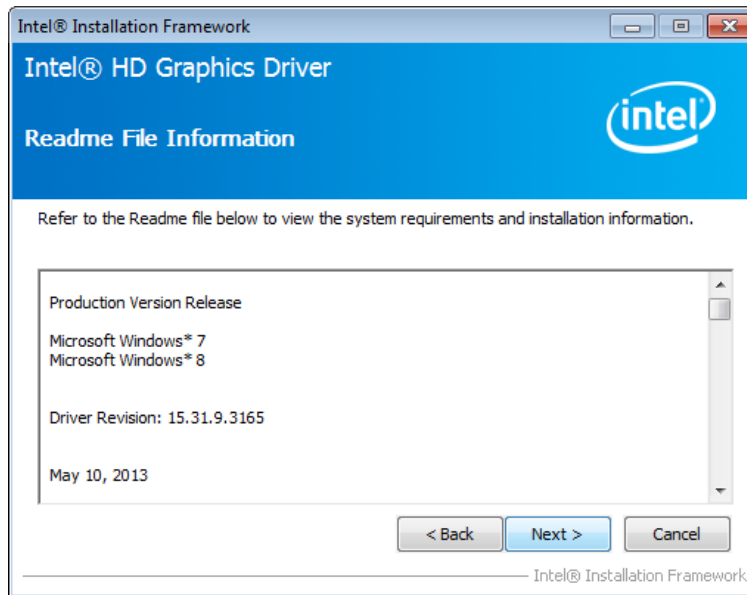

7. The installation will begin. Wait until it finishes.

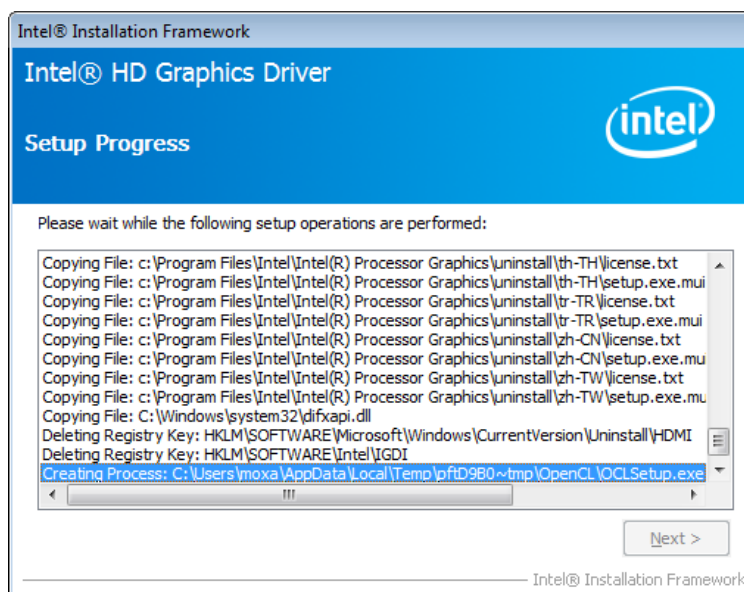
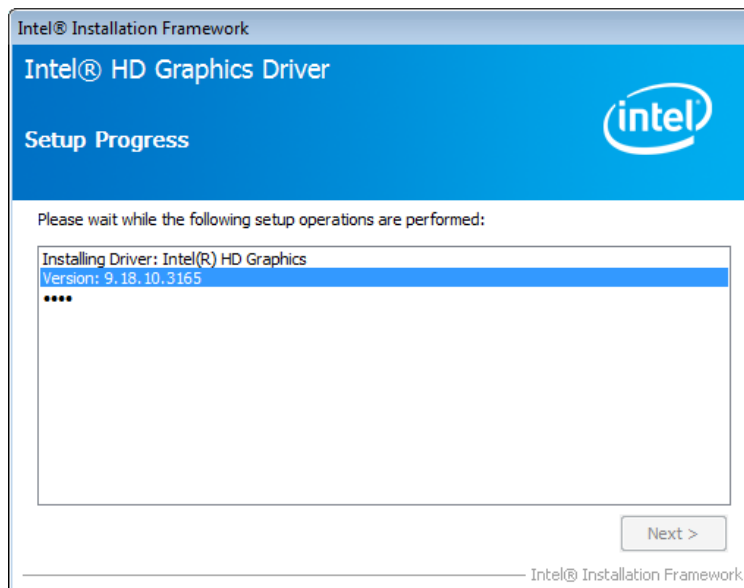

8. Click **Next** to continue.

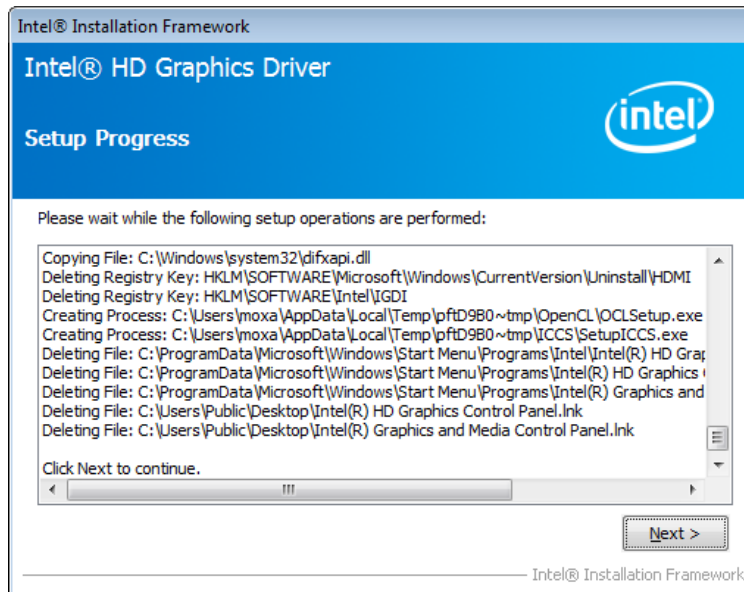

9. Select **Yes**, and then click **Finish** to complete the VGA driver installation.

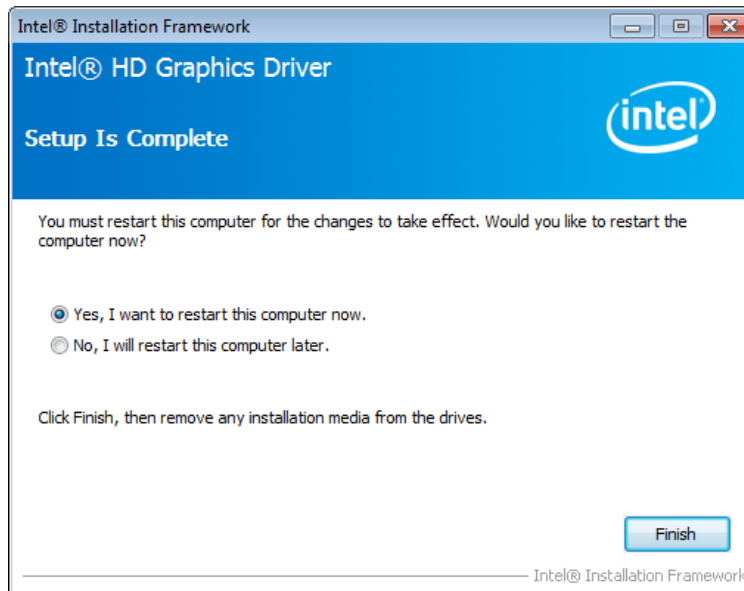

10. The MPC-2150 will restart, and you may now adjust the display resolution with the tool provided by Intel.

Adjusting Display Resolution

Follow these steps to adjust the display resolution.

1. Right-click the Intel HD Graphics Control Panel icon on the right down corner of the screen, and select **Graphics Properties**.



2. Select **Display**.

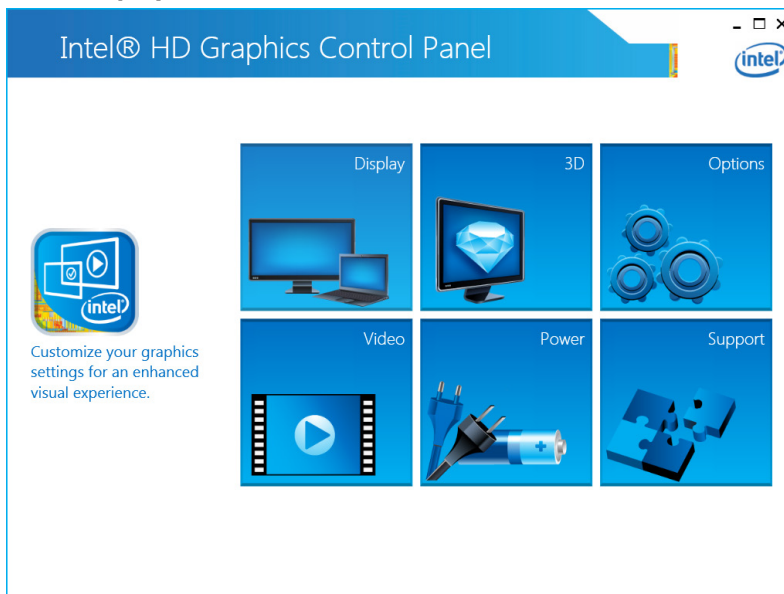

3. You can now adjust the resolution, refresh rate, and the display rotation. Select **Maintain Display Scaling**, to maximize the display so it fits the screen. Click **Apply** when finished.

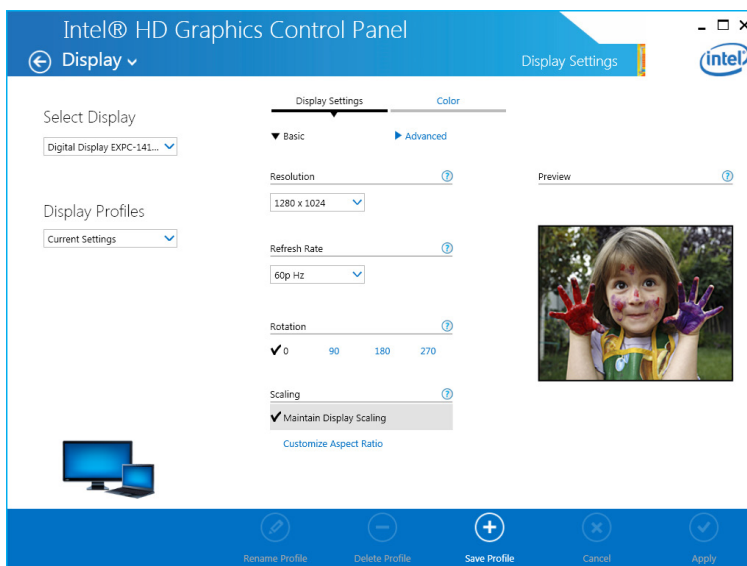

- If you want to adjust the display size, select **Customize Aspect Ratio**, and adjust by pulling the bars on the right.

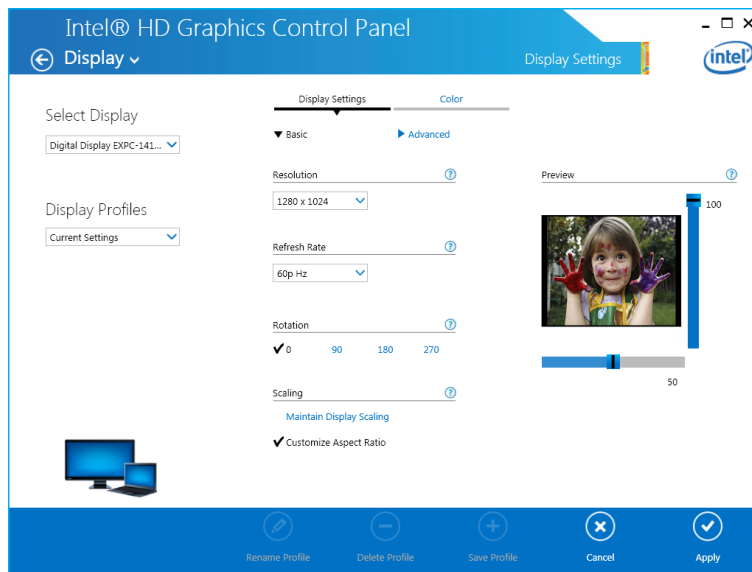

- Click **Apply** when finished.

BIOS Setup

This chapter describes the BIOS settings of the MPC-2150 Series computer. The BIOS is a set of input/output control routines for peripherals. The BIOS is used to initialize basic peripherals and helps boot the operating system before the operating system is loaded. The BIOS setup allows the user to modify the system configurations of these basic input/output peripherals. All of the configurations will be stored in the battery backed up CMOS RAM, which retains the system information after system reboots or the power is removed.

The following topics are covered in this chapter:

❑ **Entering the BIOS Setup Utility**

❑ **Main Information**

❑ **Advanced Settings**

- Boot Configuration
- HDC Configuration
- Video Configuration
- Chipset Configuration
- Hardware Monitor

❑ **Security Settings**

- Set Supervisor Password

❑ **Power Settings**

❑ **Boot Settings**

- Boot Type
- PXE Boot to LAN
- Add Boot Options
- USB Boot
- EFI Device First
- Boot Delay Time
- Legacy

❑ **Exit Settings**

- Exit Saving Changes
- Save Change Without Exit
- Exit Discarding Changes
- Load Optimal Defaults
- Load Custom Defaults
- Save Custom Defaults
- Discard Changes

❑ **Upgrading the BIOS**

Entering the BIOS Setup Utility

To enter the BIOS setup utility, press the "F2" key while the system is booting up. The main **BIOS Setup** screen will appear. Select **SCU** to enter the **BIOS configuration**.

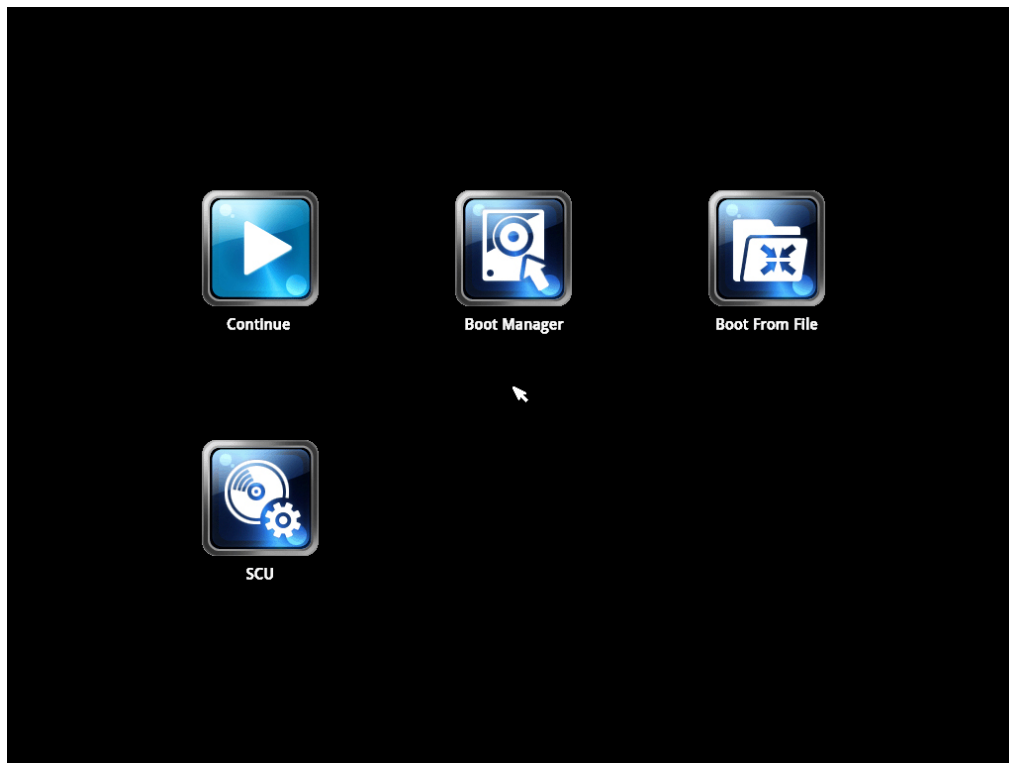

NOTE The projected capacitive touch screen function is not supported in BIOS, connect a keyboard to the MPC-2150 for BIOS configuration.

A basic description of each function key is listed at the bottom of the screen. Refer to these descriptions to learn how to use them.

F1: General Help

F5/F6: Change Values

F9: Setup Defaults

F10: Save and Exit

↑ ↓: Select Item

← →: Select Menu

ESC: Exit

ENTER: Select or go to Submenu.

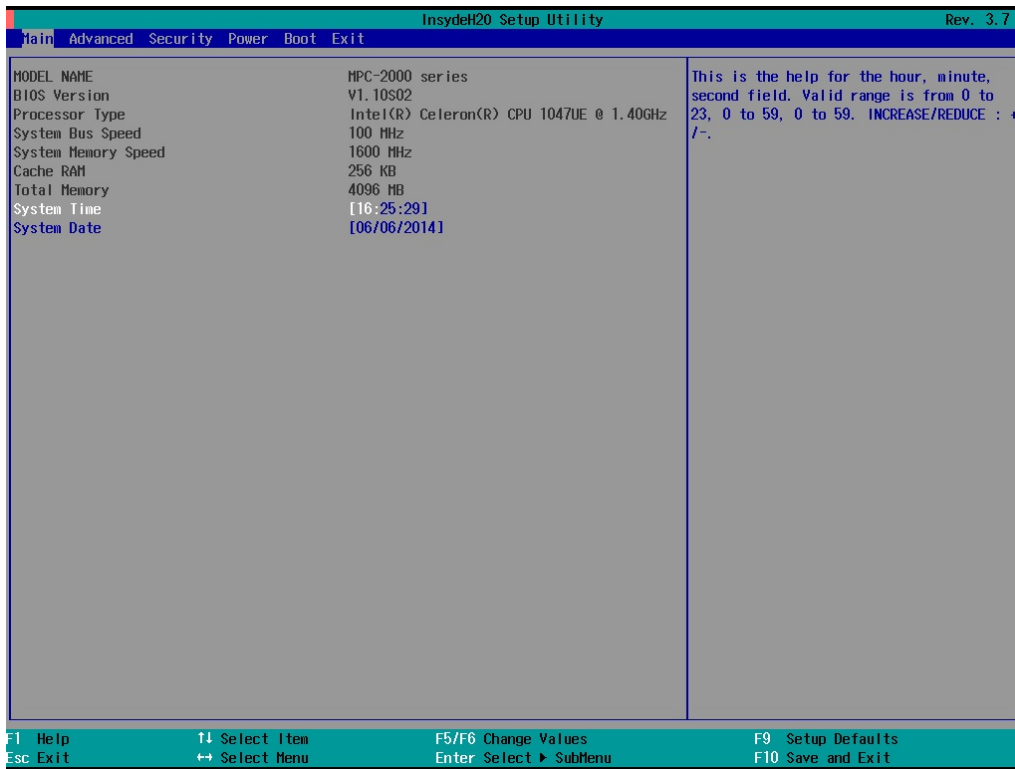

Main Information

The main page indicates the system information, such as model name, BIOS version, and CPU type. User may view the basic system hardware information in the page.

Advanced Settings

The "Advanced Features" screen will appear when choosing the "Advanced" item from the main menu.

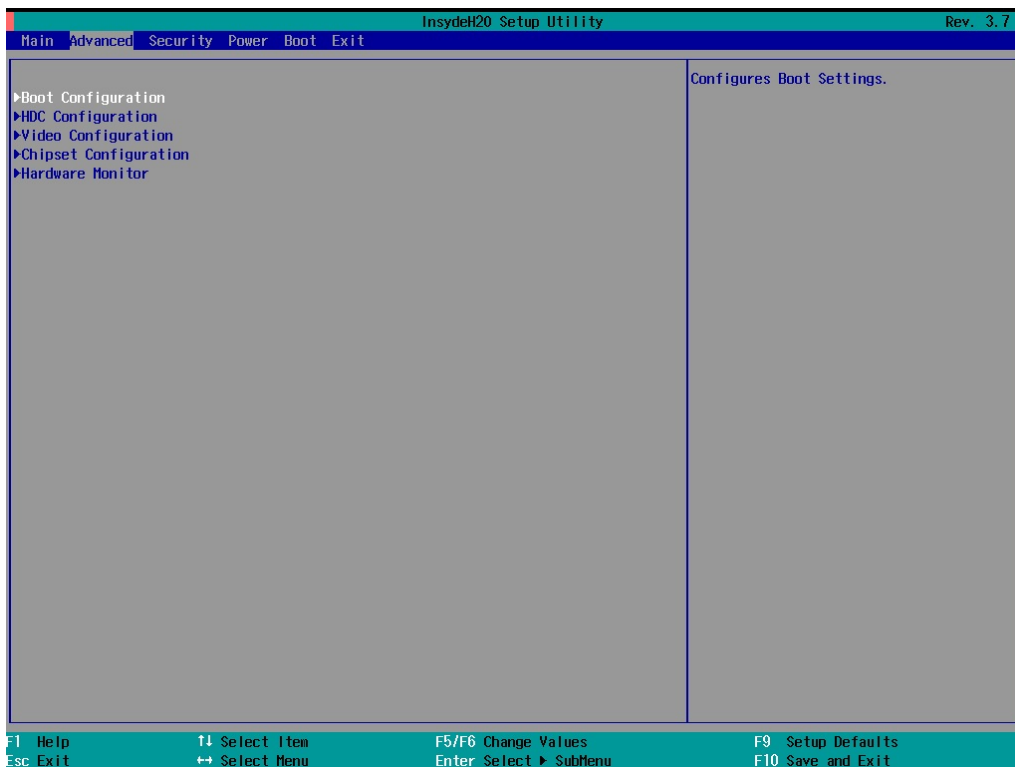

Boot Configuration

This item allows users to configure the default value of Numlock.

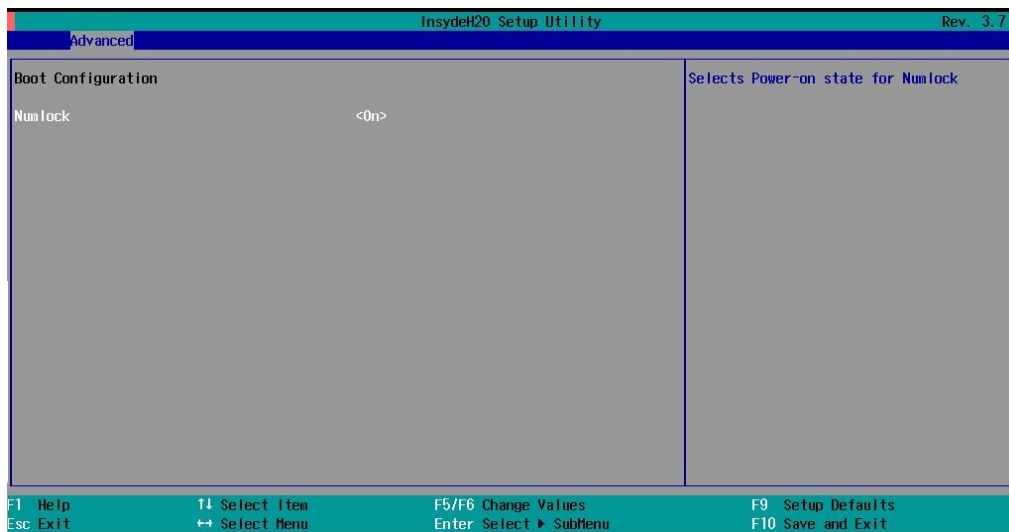

Option: On (default), Off

HDC Configuration

The host drive controller may be configured for IDE (legacy default), or AHCI mode. When the legacy IDE mode is selected, the following screen will appear.

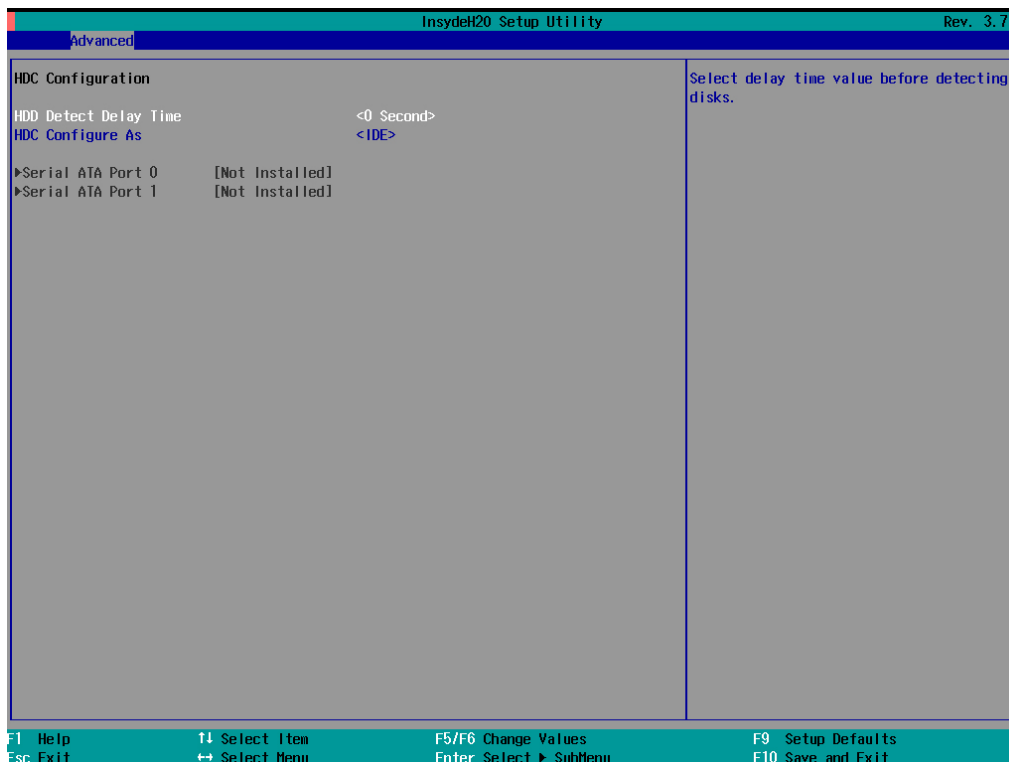

HDD Detect Delay Time

This setting allows you to configure the delaying time value before detecting the hard disks.

Option: 0 (default), 1, 2, 3 seconds.

Serial ATA Port 0 to 1

This setting allows you to display information about the installed drives.

AHCI SALP

Please note that AHCI SALP will only appear when AHCI mode is selected. This item allows you to enable **Aggressive Link Power Management** (SALP) in AHCI. SALP enables the host bus adapter to conserve power by directly detecting when a SATA drive is no longer processing information and then immediately shifting it into suspended or sleep modes without waiting for software processes to initiate power-down processes. Host Capability Register bit 26.

Options: Enabled (default), Disabled

SATA Port 0 to 1 - HotPlug

This item allows you to enable/disable hotplug capabilities (the ability to remove the drive while the computer is running) for installed storage drives.

Options: Disable (default), Enabled

Video Configuration

This item allows you to configure the integrated graphics device (IGD) for things like memory allocation (**DVMT**) and monitor types (**Boot Type**).

Internal Graphics Device

This option allows you to enable/disable the internal graphics device.

Options: Enable (default), Disable

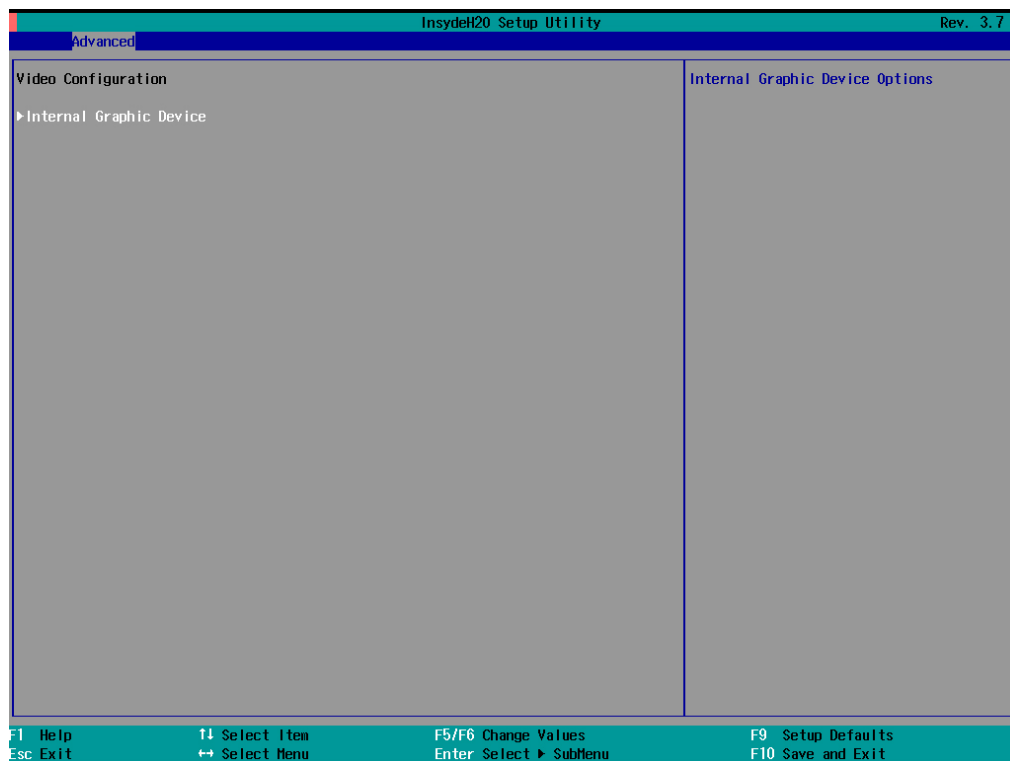

IGD—DVMT Pre-Allocated

This item allows you to configure pre-allocated memory capacity for the IGD. Pre-allocated graphics memory is invisible to the operating system.

Options: 64 MB (default), 32 MB, 96 MB, 128 MB, 256 MB, 512 MB

DVMT is a BIOS solution where the optimum amount of memory is dynamically allocated and de-allocated as needed for balanced graphics and system performance, through Intel® Direct AGP and a highly efficient memory utilization scheme. DVMT ensures the most efficient use of available system memory resources for maximum 2D/3D graphics performance.

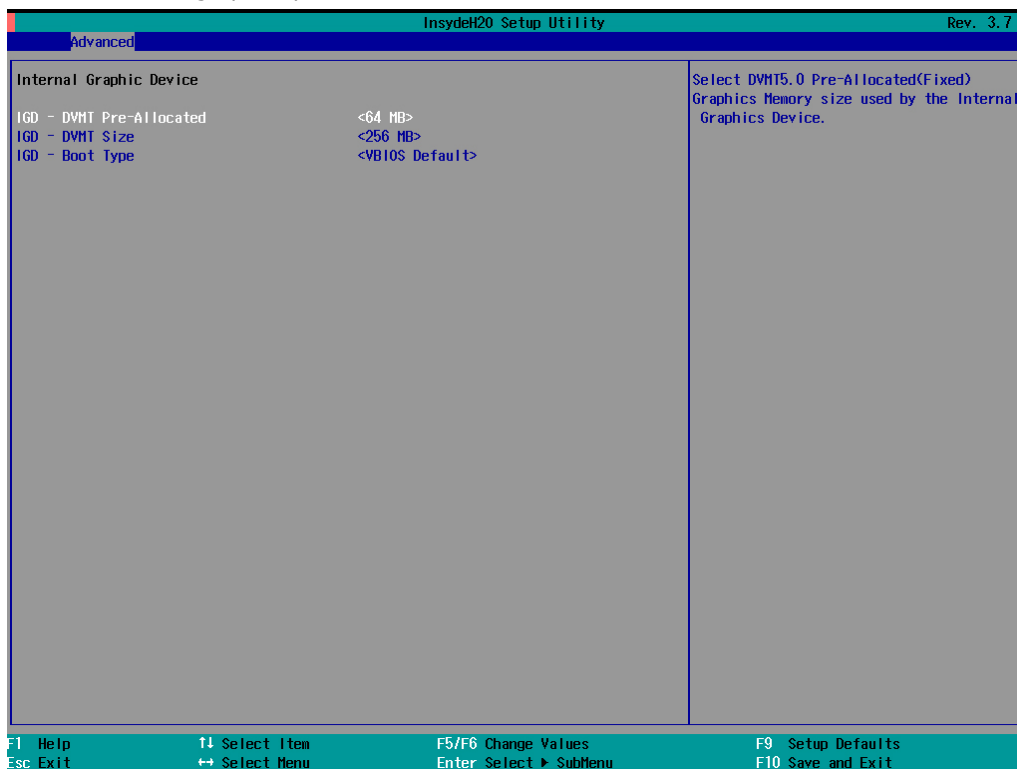

IGD—DVMT Size

This item allows you to configure the maximum amount of memory DVMT will use when allocating additional memory for the internal graphics device.

Options: 256 MB (default), 128 MB, Max

IGD – Boot Type

This item allows you to select the video device which will be activated during POST.

Options: VBIOS Default (default), VGA, DVI-D2, DVI-D1

Chipset Configuration

This item allows you to configure the chipset settings.

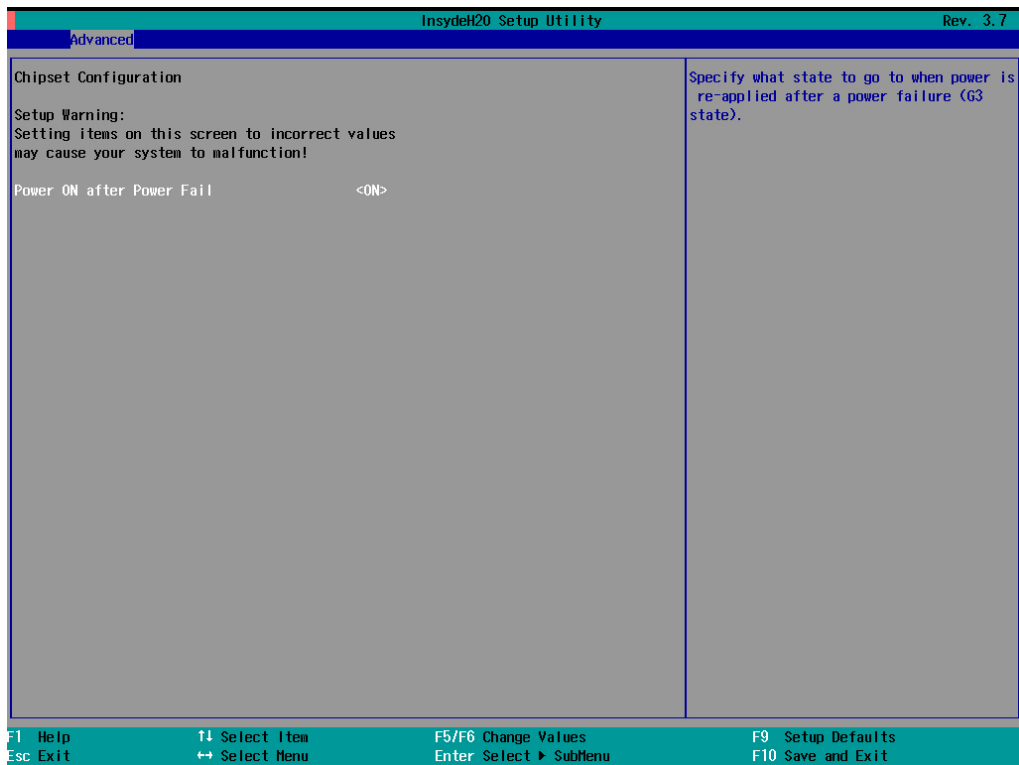

Power ON after Power Fail

This item allows you to enable/disable the computer from automatically powering up after a system crash.

Options: ON (default), OFF, Last State

Hardware Monitor

This item allows you to view stats like CPU and system temperature, voltage levels, and other chipset information.

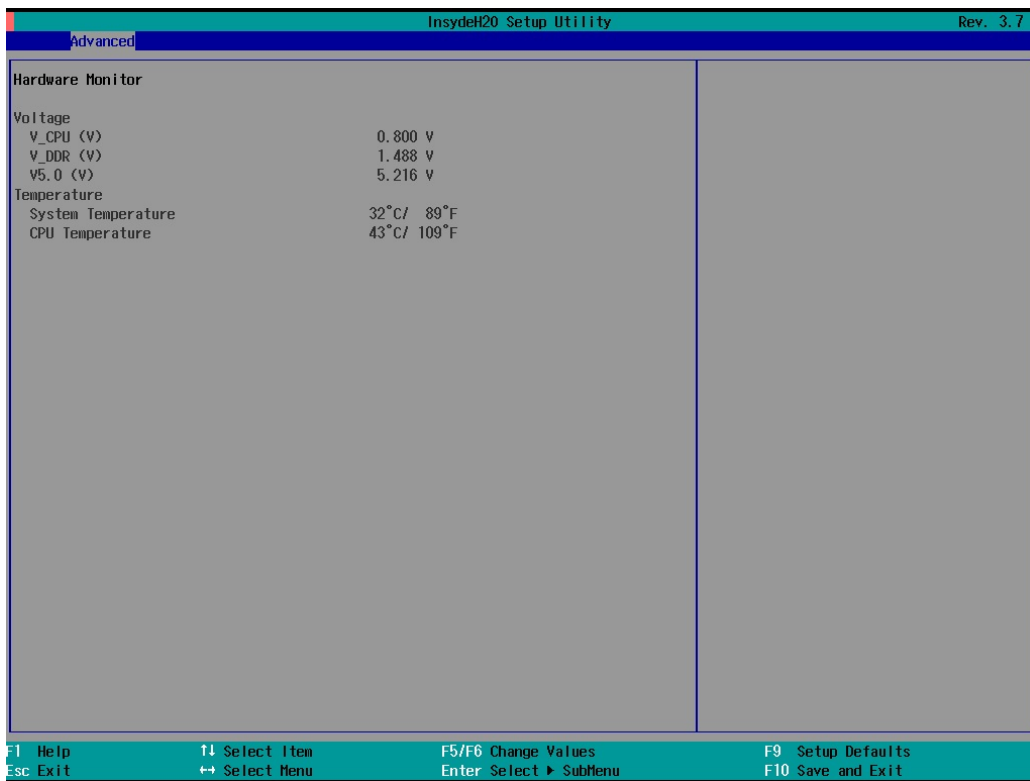

Security Settings

This section allows users to configure security settings with a supervisor password and user password.

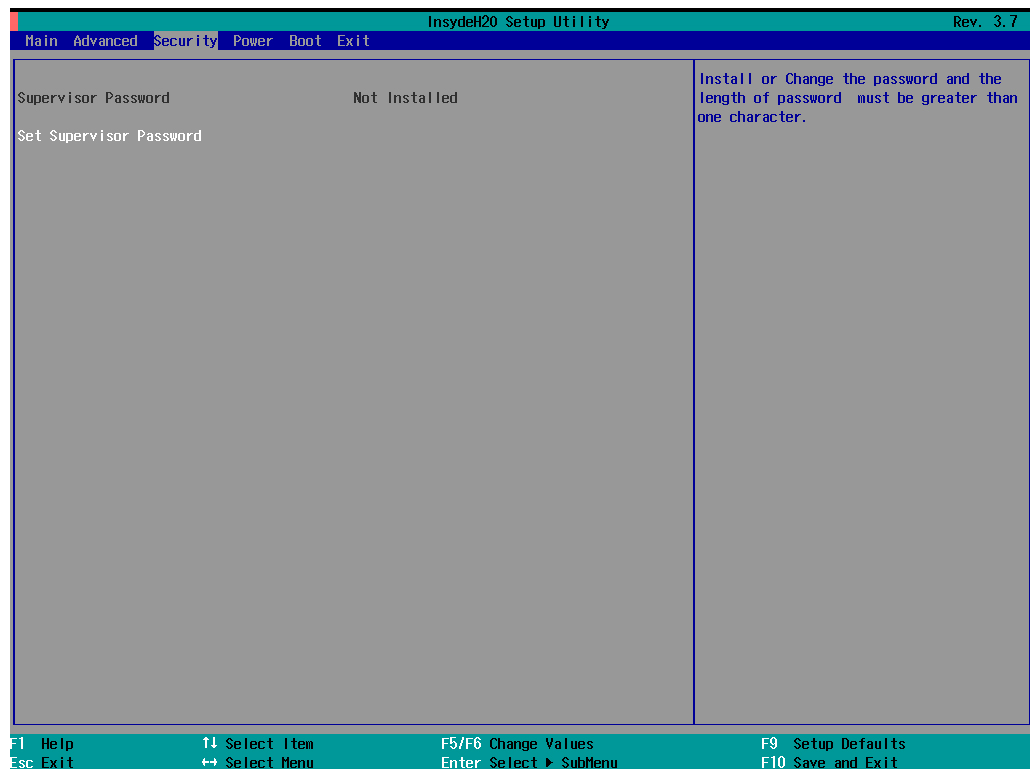

Set Supervisor Password

This item allows you set the supervisor password. Select and then enter the password, and then confirm the password again.

To delete the password, enter **Set Supervisor Password** and then enter the old password; then, leave the new password fields blank, and press enter.

Power Settings

The section allows users to configure power settings.

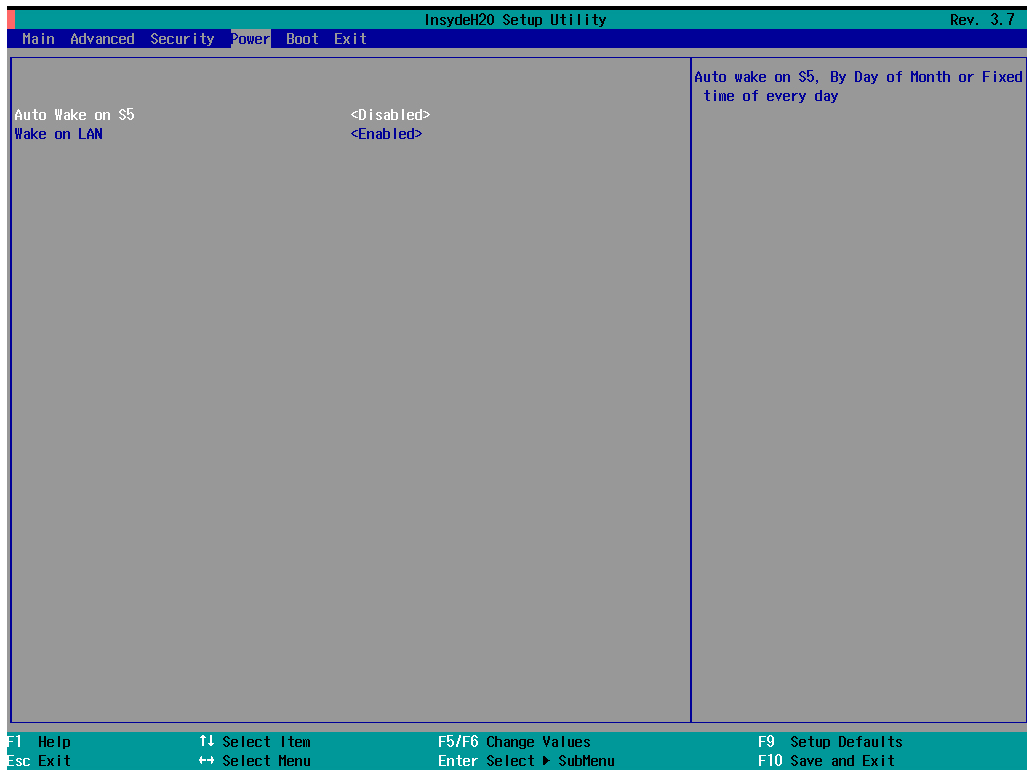

Boot Settings

The section allows users to configure boot settings.

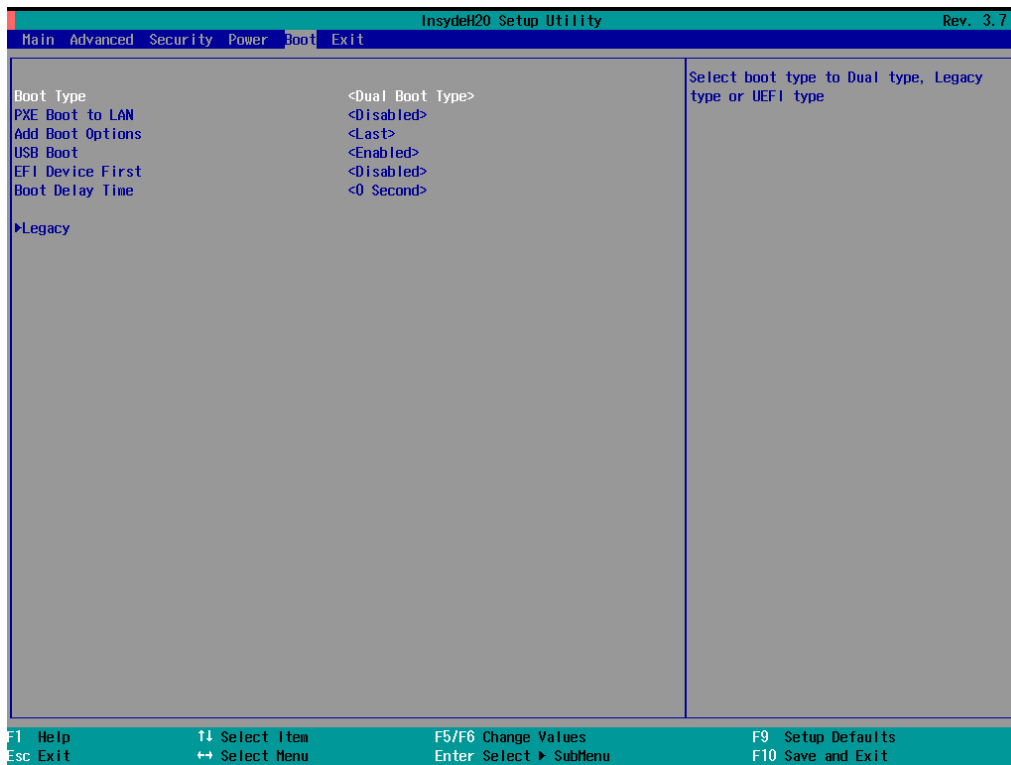

Boot Type

This item allows you to enable/disable quick boot function.

Options: Dual Boot Type (default), Legacy Boot Type, UEFI Boot Type.

PXE Boot to LAN

This item allows you to enable/disable PXE boot to LAN function.

Options: Disabled (default), Enabled

Add Boot Options

This item allows you to add the boot order options for shell, network and Removables.

Options: Last (default), First

USB Boot

This item allows you to enable/disable USB boot function.

Options: Enabled (default), Disabled

EFI Device First

This item allows you to determine EFI device first or legacy device first. If enabled, EFI device will be the first; if disabled, legacy device will be the first.

Options: Disabled (default), Enabled

Boot Delay Time

This item allows you to configure the delay time value for users to input hot key during POST time.

Options: 0 Second (default), 3 Seconds, 5 Seconds, and 10 Seconds

Legacy

Normal Boot Menu

This item allows you to configure the boot menu.

Options: Normal (default), Advance

Boot Type Order

This item allows you to select the boot order. Use F5/F6 to change values.

Options: Hard Disk Drive (default), CD/DVD-ROM Drive, USB, Others

Hard Disk Drive/USB Drive

This item allows you to view installed devices such as hard disk drives, USB drives, or CD-ROMs. For example, if you have inserted a USB drive into the computer, it will appear here.

Exit Settings

The section allows users to exit the BIOS environment.

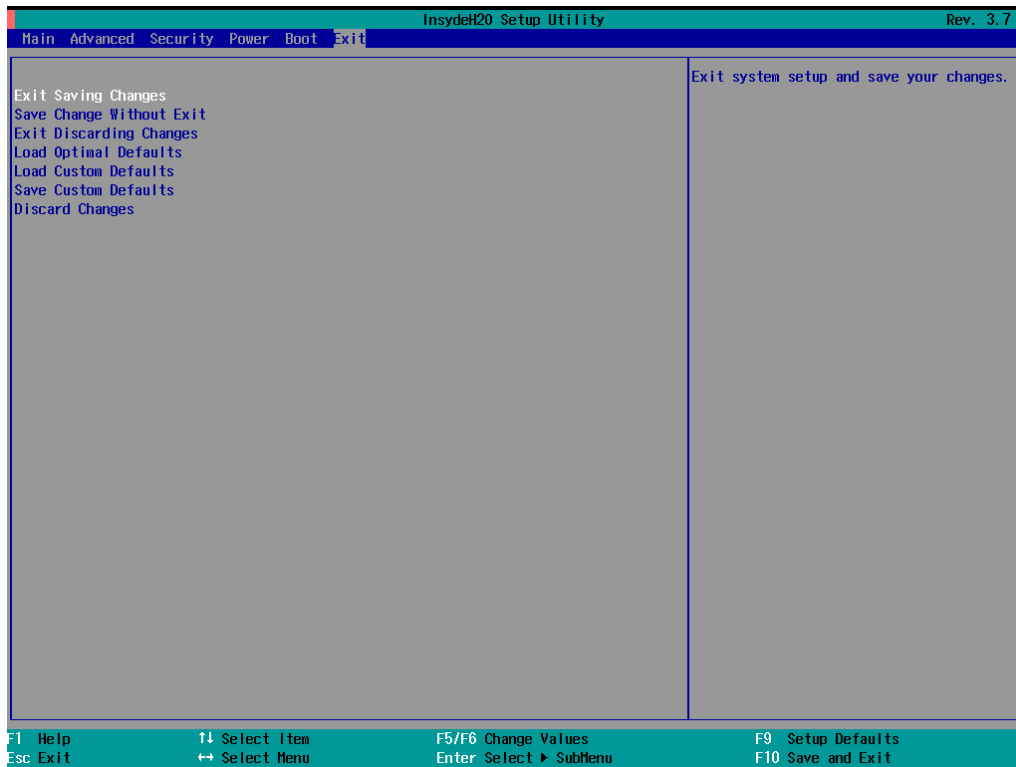

Exit Saving Changes

This item allows you to exit the BIOS environment and save the values you have just configured.

Options: Yes (default), No

Save Change Without Exit

This item allows you to save changes without exiting the BIOS environment.

Options: Yes (default), No

Exit Discarding Changes

This item allows you to exit without saving any changes that might have been made to the BIOS.

Options: Yes (default), No

Load Optimal Defaults

This item allows you to revert to the factory default BIOS values.

Options: Yes (default), No

Load Custom Defaults

This item allows you to load custom default values for the BIOS settings.

Options: Yes (default), No

Save Custom Defaults

This item allows you to save the current BIOS values as a “custom default” that may be reverted to at any time by the “load custom defaults” selection just above.

Options: Yes (default), No

Discard Changes

This item allows you to discard all settings you have just configured.

Options: Yes (default), No

Upgrading the BIOS

This section describes how to upgrade the BIOS. However, please note that it is easy to permanently damage the computer when upgrading the BIOS. We strongly recommend that you contact Moxa’s technical support staff for assistance in order to obtain all necessary tools and the most current advice before attempting to upgrade the BIOS on any Moxa device.

Step 1: Create a Bootable USB Disk

Before upgrading the BIOS every user should first create a bootable USB RAM drive as a system rescue device. You may use any software that can create a bootable USB drive. In this section, we use Rufus, which may then be downloaded and used to create a bootable RAM drive, as an example. Do the following steps to create a bootable USB disk by using Rufus.

1. Start the Rufus and in Device drop-down list select the USB device that you want to use as a bootable disk.
2. Select **MBR partition scheme for BIOS or UEFI computers**, let it can boot from legacy BIOS or UEFI.
3. Select **FAT (Default)** from File system drop-down list.
4. Select **16 kilobytes (Default)** for Cluster size.
5. Enter a drive name in **New volume label**.
6. Check **Quick format**, **Create a bootable disk using FreeDOS**, and **Create extended label and icon files**.
7. Click **Start** to format and create the bootable USB drive.

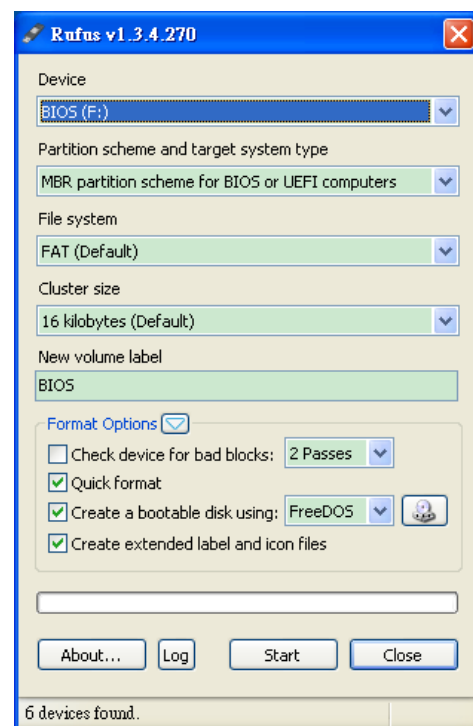

ATTENTION

We suggest you use a USB drive with under 2 GB in disk space, as larger USB drives may not support FAT file format and consequently fail to boot.

Step 2: Prepare the Upgrade File

You must use the BIOS upgrade installation file to upgrade the BIOS. Contact Moxa's technical department for assistance.

1. Get the BIOS upgrade installation file. The file name should have following format: **200xxSx.exe** (xx refers to version numbers).
2. Copy the file to the Bootable USB Disk.

Step 3: Run the upgrade program on the MPC-2150 Series Panel Computer

1. Reboot the computer, press F2 while booting up to go to the Boot Manager
2. Select USB Disk as the first boot source. Press Enter to continue.

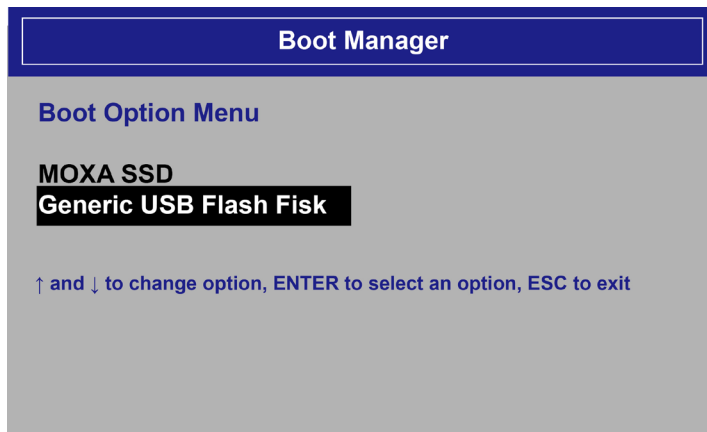

3. When boot up finishes, DOS screen will show up. Go to the directory where the upgrade file is located. For example, if the upgrade file is stored in the MPC2150 folder, type **cd MPC2150**.

```
C:\>cd MPC2150
```

4. Run the upgrade program by typing **20011S02.exe**. Please note that the upgrade filename may vary depending on the versions.

```
C:\MPC2150>20011S02.exe
```

5. The upgrade program will be automatically performed. Please wait until the procedure to be finished.

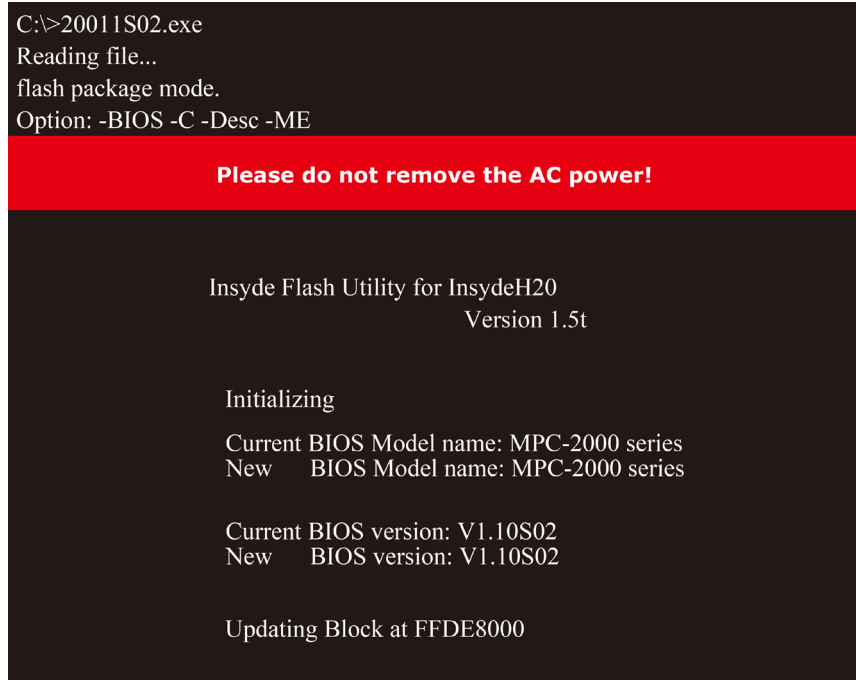

- When the upgrade is finished, the computer will automatically reboot. You may check the BIOS version in Main page of the BIOS Setup

MODEL NAME	MPC-2000 series
BIOS Version	V1.10S02
Processor Type	Intel (R) Celeron (R) CPU 1047UE @ 1.40GHz

**ATTENTION**

Do NOT switch off the power supply during the BIOS upgrade, since doing so may cause the system to crash.

Display Control Interface

This chapter describes how to use the display's control interface commands over the console.

The following topics are covered in this chapter:

- ❑ **Connecting to the Console Interface**
- ❑ **Display Control Interface Command Format**
 - Command Format Description
- ❑ **Downloading RGB Files**

Connecting to the Console Interface

If you want to use the commands in **Appendix B** to adjust the display settings, you need to connect to the display using the console interface. The following steps describe how.

The console interface is listed as the COM3 interface within the operating system. To communicate with the display over COM3, we suggest you use terminal emulator for Telnet, like Moxa's PComm.

When launching the PComm Terminal Emulator, configure the following settings:

1. Select **Port Manager**, and then select **Open**.

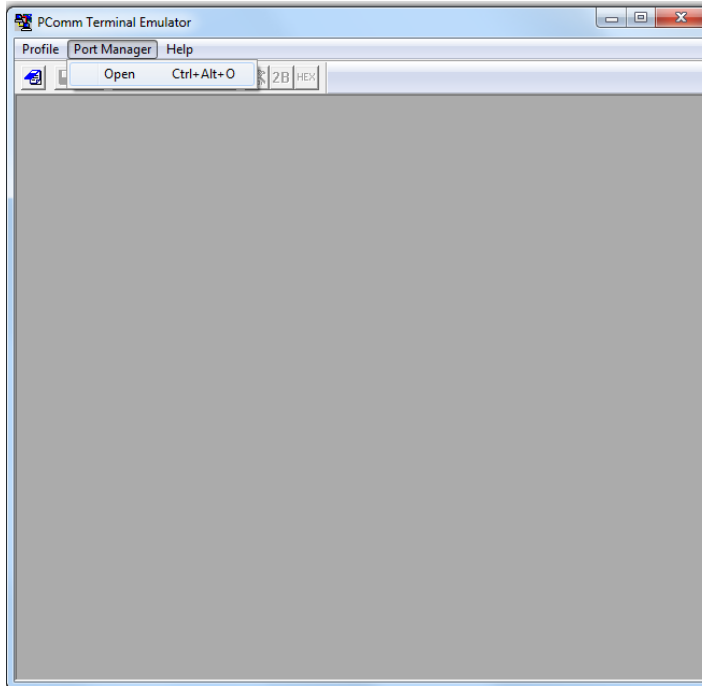

2. Configure the **Property** settings:

Protocol: Serial

Serial Parameters: COM3

Baud rate: 9600

Data bits: 8

Parity: None

Stop bits: 1

RTS state: ON

DTR state: ON

When finished, click **OK**.

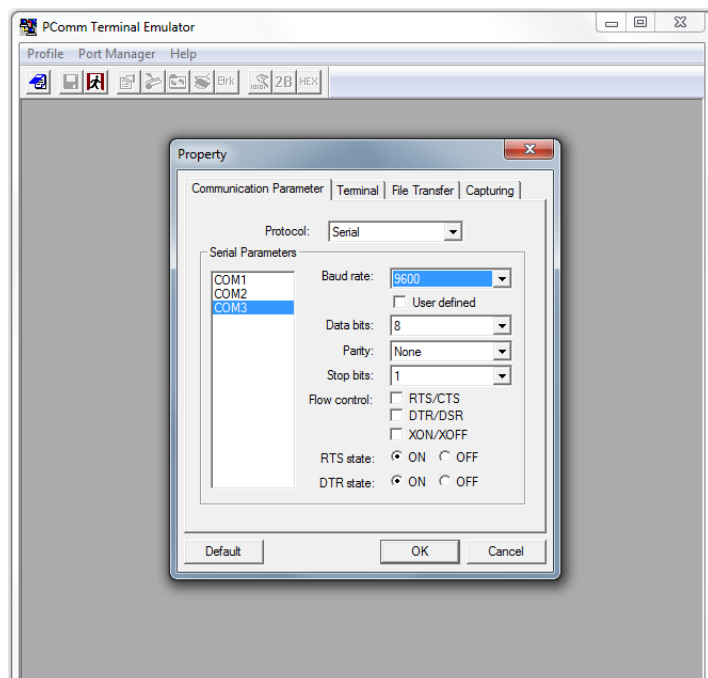

3. After successfully connecting, select the **Send pattern** tab.

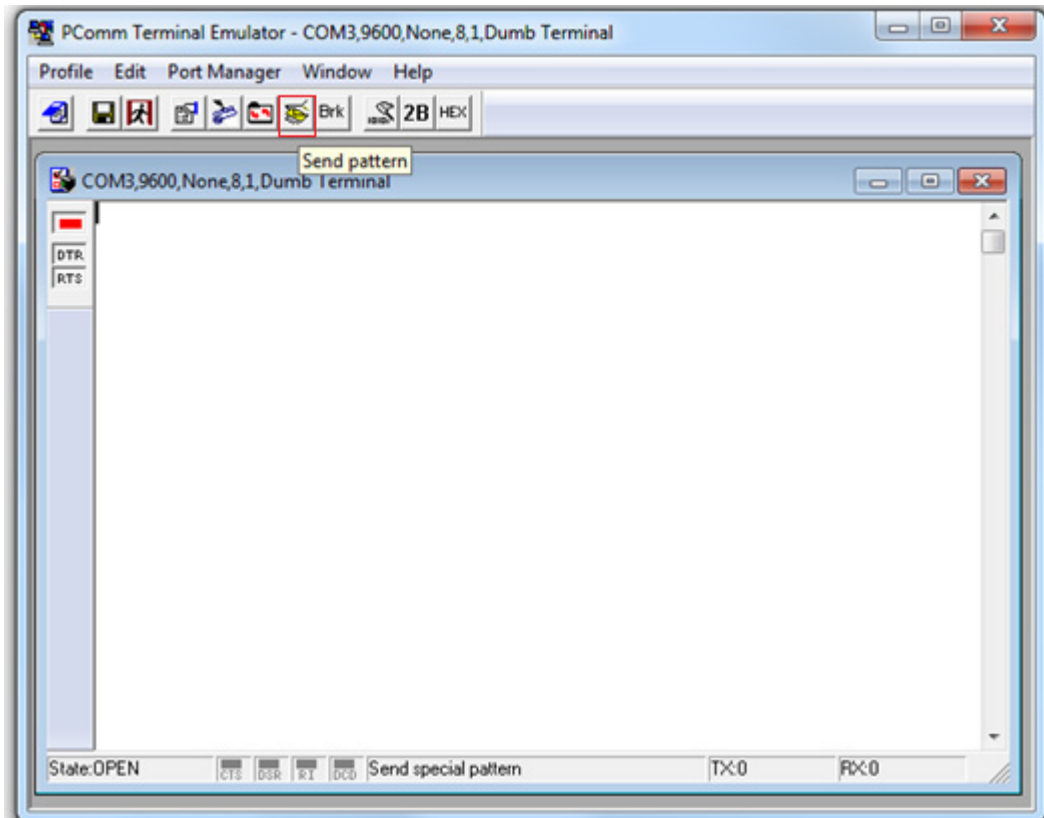

Now you can enter a command in the **HEX** field, and click **Start Send** to send the command. For example, you may send **07FF5357490006**, which queries the firmware version number (a scalar).

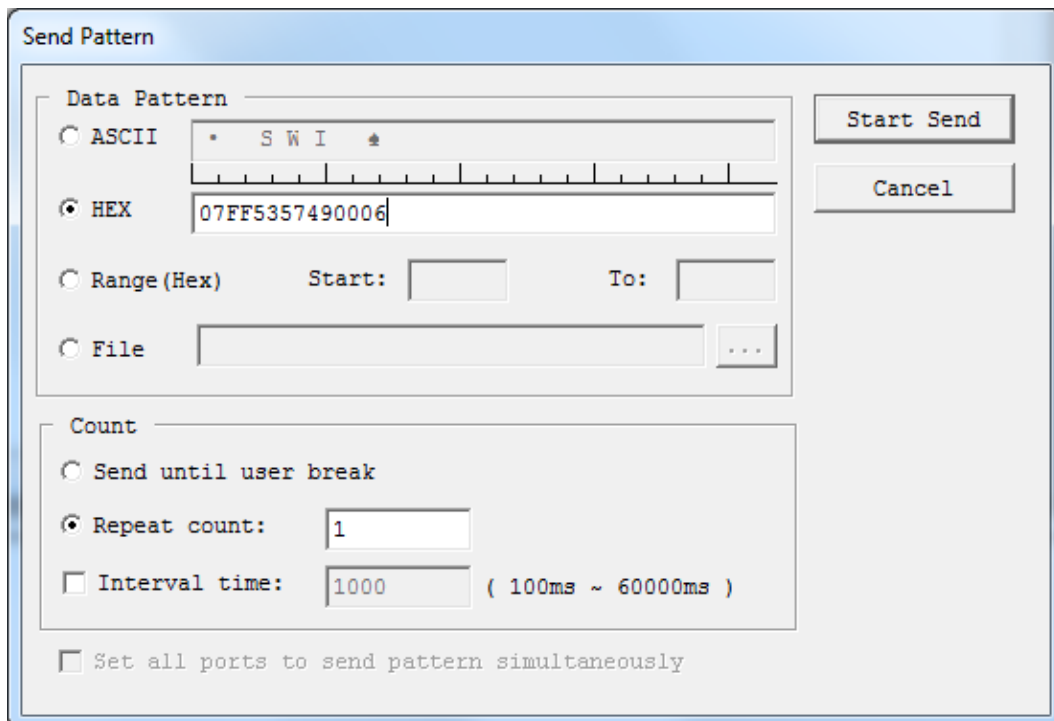

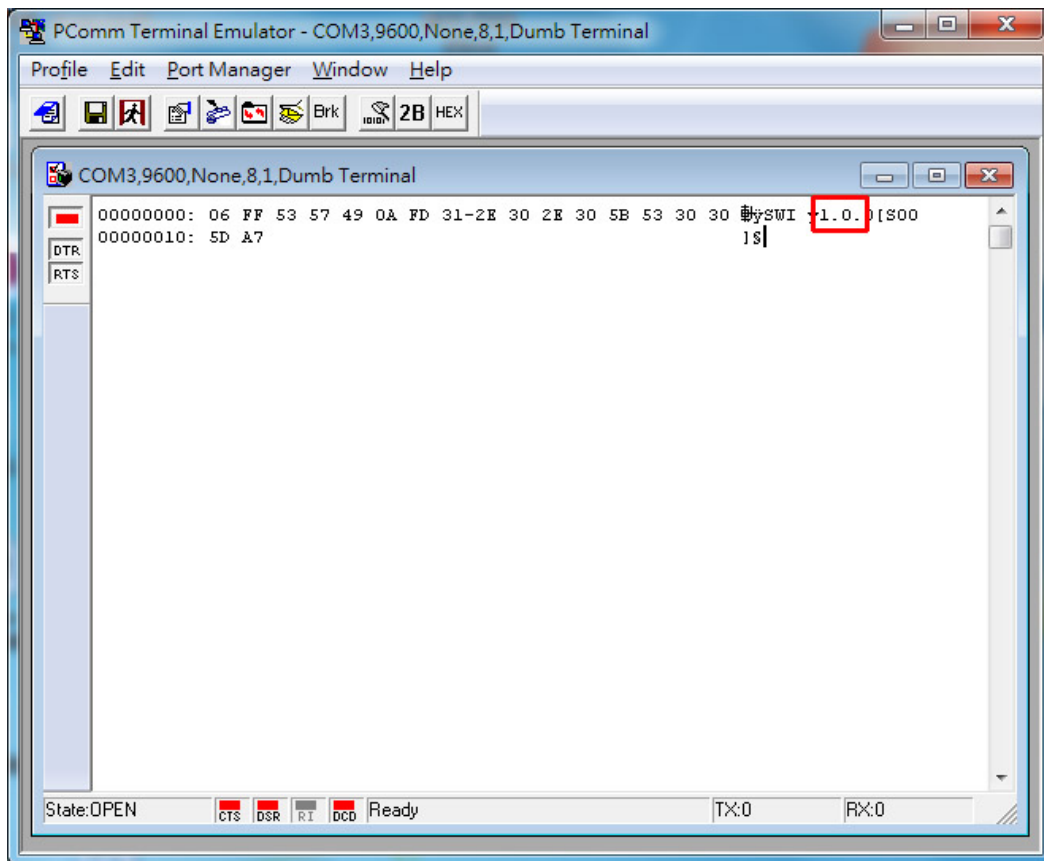

You will now see the firmware version displayed in the terminal (1.0, in the screenshot above). For details about the available commands and how they are used, refer to **Appendix B: Display Control Interface Commands**.

Display Control Interface Command Format

Each command conforms to the following packet structure:

Byte No.	0	1	2,3,4	5	6	7, etc	7+LEN
	ATTN	ADDR	CMD	LEN	IHCHK	DATA	IDCHK

The minimal command size is 7 bytes, and the maximal command size is 82 bytes.

Command Format Description

ATTN (Attention)

This byte is used to identify a start of command, and it can be one of three values:

ATTN	Description
0x07	Command (ASCII BELL)
0x06	Acknowledge (ASCII ACK)
0x15	Negative Acknowledge (ASCII NAK)

A device shall send a command using the 0x07 Attention Code. The unit will respond to the command with either an ACK if the command completed successfully, or a NAK if the command failed.

ADDR (Address)

This byte is used to specify a particular unit to receive a command and to identify the unit responding (ACK or NAK) to a command. Please note that MPC-2150 only supports broadcast address. The Address field shall have the following values:

ADDR	Description
0xFF	Broadcast - Addressed to all units

CMD (Message Commands and Queries)

The command can be one of the following values. For details, refer to **Appendix B: Display Control Interface Commands**.

CMD 0	CMD 1	CMD 2	ASCII	Description
0x42	0x52	0x49	"BRI"	Brightness Minimum Value
0x42	0x52	0x4C	"BRL"	Set LED Brightness of Touch Keypad
0x42	0x52	0x4D	"BRM"	Brightness Maximum Value
0x42	0x52	0x54	"BRT"	User Brightness Control
0x42	0x52	0x55	"BRU"	Glass Display Control - Brilliance Button
0x42	0x5A	0x5A	"BZZ"	Buzzer Control
0x44	0x4C	0x4E	"DLN"	Download ECDIS RGB package
0x44	0x4C	0x3F	"DL?"	ECDIS RGB package Query
0x45	0x54	0x43	"ETC"	Elapsed Time Counter Query
0x47	0x4D	0x42	"GMB"	Glass Display Control - Minimum Brightness
0x50	0x4F	0x54	"POT"	Potentiometer Control
0x53	0x57	0x49	"SWI"	Scalar Firmware Version Query
0x53	0x57	0x4B	"SWK"	Touch Keypad Firmware Version Query
0x41	0x44	0x46	"ADF"	AC Input Power Detect Function
0x41	0x44	0x3F	"AD?"	Query AC Input Power Detect Function Status
0x42	0x4C	0x49	"BLI"	Brightness Control
0x44	0x55	0x46	"DUF"	Disable UART Command Function
0x45	0x4D	0x53	"EMS"	ECDIS Mode Select

LEN (Data Length)

This byte defines the length of data in the message in bytes. The maximal value for this field is 74 bytes, and the minimal value is 0 byte.

IHCHK (Inverse Header Checksum)

This is a simple 8-bit checksum of the header data, message bytes 0 to 5. The 8-bit sum (without carry) of bytes 0, 1, 2, 3, 4, 5, and 6 shall be 0xFF.

If a message is received with an incorrect checksum, the display will replay with the attention code set to NAK.

DATA (Data Field)

The data field shall only be transmitted if LEN is larger than 0. This field depends on the CMD transmitted.

IDCHK (Inverse Data Checksum)

These bytes shall be only transmitted if LEN is larger than 0. This is a simple 8-bit checksum of the data field, message bytes 7 to 7+ (LEN-1).

The 8-bit sum (without carry) of bytes 7 through 7+LEN inclusive shall be 0xFF. The receiver will reply to any message that the checksum has failed with the attention code set to NAK.

Downloading RGB Files

Use the following commands for downloading RGB files.

Commands	Description
DL?	Data: none (0 byte) ACK: Total packet numbers (1 byte)
DLN	Data: Appointed packet (1 byte) ACK: File content (30 bytes maximum, except for the last packet)

The **DL?** command will send a request to the micro controller and ask how many packets that need to be downloaded. The reply from the micro controller shall be used when using the command DLN to download the specific packets. Refer to the following section for detailed descriptions of the **DL?** and **DLN** commands.

Command DL?

Byte No.	Byte 0	Byte 1	Byte 2	Byte 3	Byte 4	Byte 5	Byte 6
Hex	0x7	0xFF	0x44	0x4C	0x3F	0x0	0x2A
ASCII			D	L	?		

Command DLN

Byte No.	Byte 0	Byte 1	Byte 2	Byte 3	Byte 4	Byte 5	Byte 6	Byte 7	Byte 8
Hex	0x7	0xFF	0x44	0x4C	0x4E	0x1	0x1A	0x50	0xAF
ASCII			D	L	N				

Here is the example of downloading the RGB file package 0:

Command to read package 0.

0x07	0xFF	0x44	0x4C	0x4E	0x01	0x1A	0x00	0xFF		
------	------	------	------	------	------	------	------	------	--	--

ACK the package 0 of the first RGB file

0x06	0xFF	0x44	0x4C	0x4E	0x20	0xFC	0x00	-	Data	IDCHK
------	------	------	------	------	------	------	------	---	------	-------

Data should be the real value of the RGB file package 0.

A

Regulatory Approval Statement



This device complies with part 15 of the FCC Rules. Operation is subject to the following two conditions: (1) This device may not cause harmful interference, and (2) this device must accept any interference received, including interference that may cause undesired operation.

Class A: FCC Warning! This equipment has been tested and found to comply with the limits for a Class A digital device, pursuant to part 15 of the FCC Rules. These limits are designed to provide reasonable protection against harmful interference when the equipment is operated in a commercial environment. This equipment generates, uses, and can radiate radio frequency energy and, if not installed and used in accordance with the instruction manual, may cause harmful interference to radio communications. Operation of this equipment in a residential area is likely to cause harmful interference in which case the user will be required to correct the interference at his/her own expense.



European Community

Warning:

This is a **Class A** product. In a domestic environment this product may cause radio interference, in which case the user may be required to take compensatory measures.

Display Control Interface Commands

This chapter defines the serial data format and the serial communication protocol so that engineers can use them to program the MPC-2150 panel computer...

This appendix explains how to use the display control interface commands.

The following topics are covered:

□ Display Control Interface Commands

- BRI (Brightness Minimum Value)
- BRL (Set LED Brightness of Touch Keypad)
- BRM (Brightness Maximum Value)
- BRT (User Brightness Control)
- BRU (Glass Display Control-Brightness Button)
- BZZ (Buzzer Control)
- DLN (Download ECDIS RGB Package)
- DL? (ECDIS RGB Package Query)
- ETC (Elapsed Time Counter Query)
- GMB (Glass Display Control - Minimum Brightness)
- POT (Potentiometer Control)
- SWI (Scalar Firmware Version Query)
- SWK (Touch Keypad Firmware Version Query)
- ADF (AC Input Power Detect Function)
- AD? (Query AC Input Power Detect Function Status)
- BLI (Brightness Control)
- DUF (Disable UART Command Function)
- EMS (ECDIS Mode Select)

Display Control Interface Commands

This section describes the display control interface commands that can be used to configure the display. See the following descriptions.

BRI (Brightness Minimum Value)

This command is to set the brightness minimum value. The range starts from 0x00 to 0x31 (0% - 100%). LEN=one data byte.

Example:

Command to set 30% brightness.

0x07	0xFF	0x42	0x52	0x49	0x01	0x1B	0x10	0xEF
------	------	------	------	------	------	------	------	------

BRL (Set LED Brightness of Touch Keypad)

This command is to set led brightness value of touch keypad. The range starts from 0x00 to 0x31 (0% - 100%). The default brightness value of the touch keypad will be changed in the ratio of the panel backlight brightness. You can send the ? command to query the current value of the LED brightness. LEN=one data byte.

Example:

Command to set 100% Brightness.

0x07	0xFF	0x42	0x52	0x4C	0x01	0x18	0x31	0xCE
------	------	------	------	------	------	------	------	------

BRM (Brightness Maximum Value)

This command is to set the brightness maximum value. The range starts from 0x00 to 0xFF (0% - 100%). LEN=one data byte.

Example:

Command to set 88% Brightness.

0x07	0xFF	0x42	0x52	0x4D	0x01	0x17	0xE0	0x1F
------	------	------	------	------	------	------	------	------

BRT (User Brightness Control)

This command is to set maximum brightness of the panel. The range starts from 0x00 to 0xFF (0% - 100%). The default value is **0xFF**.

Please note whenever the MPC-2150 has been restarted, the BRT value will be reset to 100%. If the BRT value has been changed (the BRT value does not equal to 0xff), the ECDIS function will not be supported and the ECDIS function keys will be disabled and turned off.

If the data and data checksum of sending are incorrect, the data field of replying is the current BRT value. LEN=one data byte.

Example:

Command to set 40% Brightness.

0x07	0xFF	0x42	0x52	0x54	0x01	0x10	0x66	0x99
------	------	------	------	------	------	------	------	------

ACK was set to 40% Brightness

0x06	0xFF	0x42	0x52	0x54	0x01	0x11	0x66	0x99
------	------	------	------	------	------	------	------	------

NAK was default Brightness 100%

0x15	0xFF	0x42	0x52	0x54	0x01	0x02	0xFF	0x00
------	------	------	------	------	------	------	------	------

BRU (Glass Display Control-Brightness Button)

This command is to set led brightness value of the touch keypad. The range starts from 0x00 to 0xFF (0% - 100%). The default brightness value of the touch keypad will be changed in the ratio of the panel backlight brightness.

You can send the ? command to query the current value of the LED brightness. LEN=one data byte.

Example:

Command to set 100% Brightness.

0x07	0xFF	0x42	0x52	0x55	0x01	0x0F	0xFF	0x00
------	------	------	------	------	------	------	------	------

BZZ (Buzzer Control)

The default value for the buzzer is **OFF**. Users can send this command to turn on/off the buzzer.

If the data and data checksum of sending are incorrect, the data field of replying is current buzzer status.

LEN=one byte.

0x00	Turn the buzzer OFF
0xFF	Turn the buzzer ON

Example:

Turn the buzzer **ON**.

0x07	0xFF	0x42	0x5A	0x5A	0x01	0x02	0xFF	0x00
------	------	------	------	------	------	------	------	------

ACK

0x06	0xFF	0x42	0x5A	0x5A	0x01	0x03	0xFF	0x00
------	------	------	------	------	------	------	------	------

DLN (Download ECDIS RGB Package)

Before sending this command, use **DL?** to know the number of packets available in each ECDIS table. This command cannot be used if the MPC-2150 has not been calibrated. Every packet has a head (Byte 7 and Byte 8), Byte 7 is this packet number and Byte 8 is "-" with ASCII, and after the Bytes are data. If packet is full the data is Byte 9 to Byte 38. LEN=one data byte.

Data length is 32. The first byte is package num., the second byte is "-" and the other 30 byte is data.

Example:

Command to read package 0.

0x07	0xFF	0x44	0x4C	0x4E	0x01	0x1A	0x00	0xFF		
------	------	------	------	------	------	------	------	------	--	--

ACK the package 0 of the first RGB file

0x06	0xFF	0x44	0x4C	0x4E	0x20	0xFC	0x00	-	Data	IDCHK
------	------	------	------	------	------	------	------	---	------	-------

DL? (ECDIS RGB Package Query)

Use **DL?** to know the number of packets available in each ECDIS table. This command cannot be used if the MPC-2150 has not been calibrated. Total package num = Size of ECDIS RGB file/30 bytes per package.

Example:

Send **DL?** command to query total package num. of the first RGB file.

0x07	0xFF	0x44	0x4C	0x3F	0x00	0x2A		
------	------	------	------	------	------	------	--	--

ACK 255 packages

0x06	0xFF	0x44	0x4C	0x3F	0x01	0x2A	0xFF	0x00
------	------	------	------	------	------	------	------	------

ETC (Elapsed Time Counter Query)

This command is to query the elapsed time that the MPC-2150 has been operated. The MPC-2150 will reply to this command with an ACK attention code. The largest byte will be transmitted first.

The maximum indicator for this function is 99999 hours (defined into 5 bytes, numbers 0 to 9 each), equivalent to 11 years. If this number is reached, the ETC will stop counting, and the ETC command will always reply with maximum number of hours (99999).

Example:

Send **ETC** to query elapsed time:

0x07	0xFF	0x45	0x54	0x43	0x00	0x1D
------	------	------	------	------	------	------

ACK 99999 hours

06	FF	45	54	43	05	19	39	39	39	39	39	E2
----	----	----	----	----	----	----	----	----	----	----	----	----

GMB (Glass Display Control - Minimum Brightness)

This command is to set the minimum value limit for the brightness of touch keypad LED to make sure that the LED indicators are still visible if they was previously adjusted down to a very low value. The range starts from 0x00 to 0x31 (0% - 100%). LEN=one date byte.

Example:

Command to set 30% Brightness.

0x07	0xFF	0x47	0x4D	0x42	0x01	0x22	0x10	0xEF
------	------	------	------	------	------	------	------	------

POT (Potentiometer Control)

The BR+/BR- key default value is **Enable**. Users can send this command to disable/enable BR+/BR- key. If the data and data checksum of sending are incorrect, the data field of replying is current control status. LEN=one date byte.

0x00	Brightness +/Brightness - Key Disable
0xFF	Brightness +/Brightness - Key Enable

Example:

Disable the BR+/BR- Key.

0x07	0xFF	0x50	0x4F	0x54	0x01	0x05	0x00	0xFF
------	------	------	------	------	------	------	------	------

ACK

0x06	0xFF	0x50	0x4F	0x54	0x01	0x06	0x00	0xFF
------	------	------	------	------	------	------	------	------

SWI (Scalar Firmware Version Query)

This command is to query the scalar firmware version.

Example:

Query Scalar Firmware Version

0x07	0xFF	0x53	0x57	0x49	0x00	0x06
------	------	------	------	------	------	------

SWK (Touch Keypad Firmware Version Query)

This command is to query the touch keypad firmware version.

Example:

Query Touch Keypad Firmware Version

0x07	0xFF	0x53	0x57	0x4B	0x00	0x04
------	------	------	------	------	------	------

ADF (AC Input Power Detect Function)

This default value of this function is **OFF**. If the MPC-2150 supports AC power input, users can turn on this function to detect AC input power when the MPC-2150 has connected to the AC power. LEN=one data byte.

0x00	AC Input Power Detect is OFF
0xFF	AC Input Power Detect is ON

Example:

Set "OFF".

0x07	0xFF	0x41	0x44	0x46	0x01	0x2D	0x00	0xFF
------	------	------	------	------	------	------	------	------

ACK

0x06	0xFF	0x41	0x44	0x46	0x01	0x2E	0x00	0xFF
------	------	------	------	------	------	------	------	------

AD? (Query AC Input Power Detect Function Status)

If the MPC-2150 supports AC power input, users can use command is to query AC Input Power Detect Function Status.

0x00	AC Input Power Detect is OFF
0xFF	AC Input Power Detect is ON

Example:

Send the **AD?** command to Query the AC Input Power Detect Function Status

0x07	0xFF	0x41	0x44	0x3F	0x00	0x35
------	------	------	------	------	------	------

ACK

0x06	0xFF	0x41	0x44	0x3F	0x01	0x35	0x00	0xFF
------	------	------	------	------	------	------	------	------

BLI (Brightness Control)

This command is to set the panel brightness. Brightness range is from 0x00 to 0xFF. Default Brightness is 160. LEN=one data byte.

Example:

Set brightness to 255(0xFF)

0x07	0xFF	0x42	0x4C	0x49	0x01	0x21	0xFF	0x00
------	------	------	------	------	------	------	------	------

ACK

0x06	0xFF	0x42	0x4C	0x49	0x01	0x22	0xFF	0x00
------	------	------	------	------	------	------	------	------

Query current brightness value

0x07	0xFF	0x42	0x4C	0x49	0x00	0x22
------	------	------	------	------	------	------

ACK

0x06	0xFF	0x42	0x4C	0x49	0x01	0x22	0xFF	0x00
------	------	------	------	------	------	------	------	------

DUF (Disable UART Command Function)

Users can use this command to disable related command control. LEN=one data byte.

DATA	IDCHK	Function description
0x00	0xFF	Disable all command control
0x01	0xFE	Disable BRI control
0x02	0xFD	Disable BRL control
0x04	0xFB	Disable BRM control
0x08	0xF7	Disable BZZ control
0x10	0xEF	Disable ETC control
0x20	0xDF	Disable GMB control
0x40	0xBF	Disable POT control

Example:

Disable all command control

0x07	0xFF	0x44	0x55	0x46	0x01	0x19	0x00	0xFF
------	------	------	------	------	------	------	------	------

ACK

0x06	0xFF	0x44	0x55	0x46	0x01	0x1A	0x00	0xFF
------	------	------	------	------	------	------	------	------

NACK

0x15	0xFF	0x44	0x55	0x46	0x01	0x0B	0x00	0xFF
------	------	------	------	------	------	------	------	------

EMS (ECDIS Mode Select)

For the ECDIS models, users can use this command to switch DAY, DUSK and NIGHT mode. LEN=one data byte.

	DATA	IDCHK
DAY	0x00	0xFF
DUSK	0x01	0xFE
NIGHT	0x02	0xFD

Example:

Switch to DUSK mode

0x07	0xFF	0x45	0x4D	0x53	0x01	0x13	0x01	0xFE
------	------	------	------	------	------	------	------	------

ACK

0x06	0xFF	0x45	0x4D	0x53	0x01	0x14	0x01	0xFE
------	------	------	------	------	------	------	------	------

NACK

0x15	0xFF	0x45	0x4D	0x53	0x01	0x0B	0x01	0xFE
------	------	------	------	------	------	------	------	------

C

Configure Serial Interface

This chapter provides examples to illustrate how to use the MPC-2150 computer with the **SerialInterface** utility.

The following topics are covered in this appendix:

- **Overview**
- **Installing the SerialInterface Utility**
- **Configuring the Serial Interface Mode**

Overview

The MPC-2150 supports the following serial modes: **RS-232, RS-422, 2-wire RS-485, and 4-wire RS-485**. These modes can be configured on COM1 and COM2.

Installing the SerialInterface Utility

Complete the following steps to install the SerialInterface utility:

1. The SerialInterface setup *.exe file can be found on the product DVD: <Software DVD>\utility\SerialInterface\x64 to. Execute "Mxsp_MPC-2240_2190_2150_1.0_x64_Setup.exe" and when the application program launches, click **Next** to continue, and then click **Next** again.

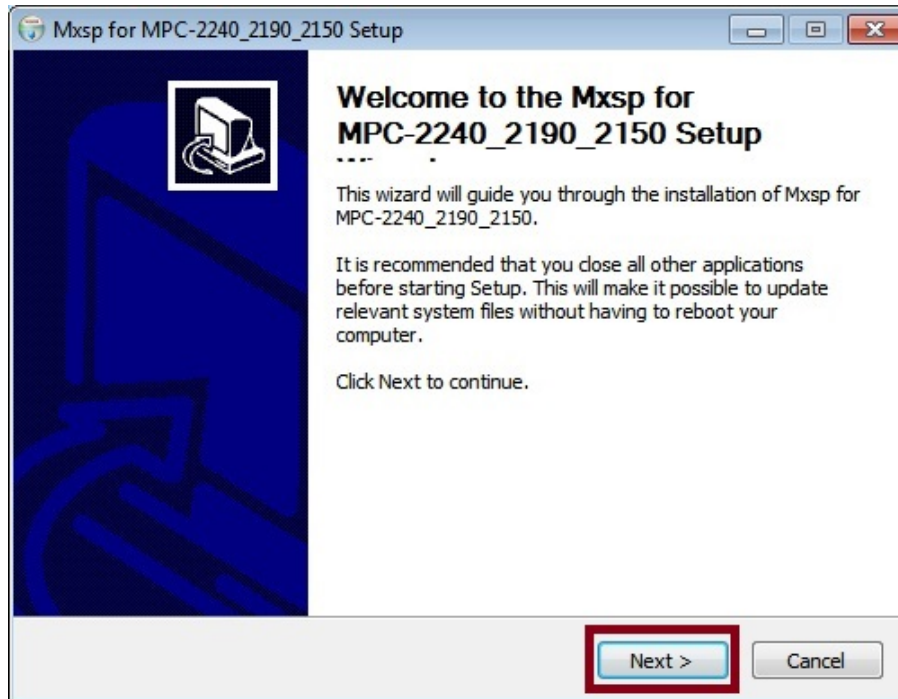

2. Click **Next** to continue.

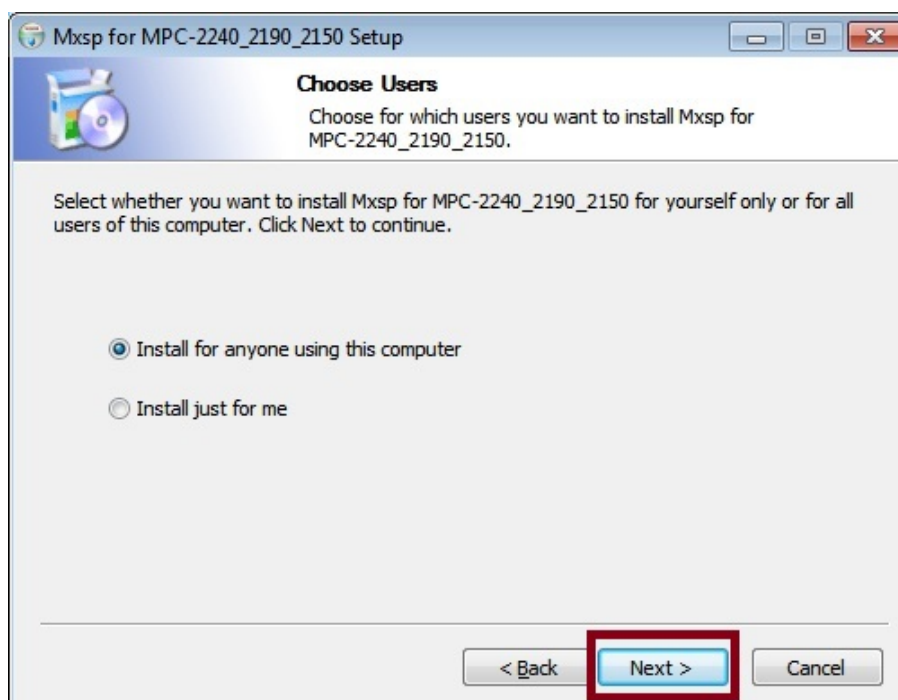

3. The default destination folder is **C:\Program Files(x86)\Moxa\Mxsp**; click **Install** to continue.

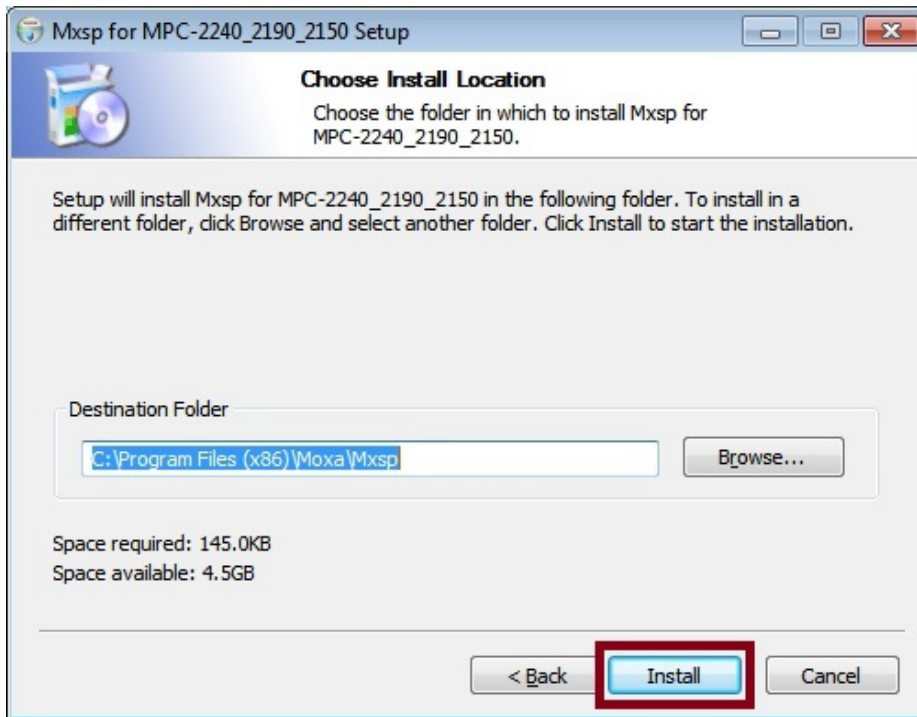

4. Click **Finish** to complete installation.

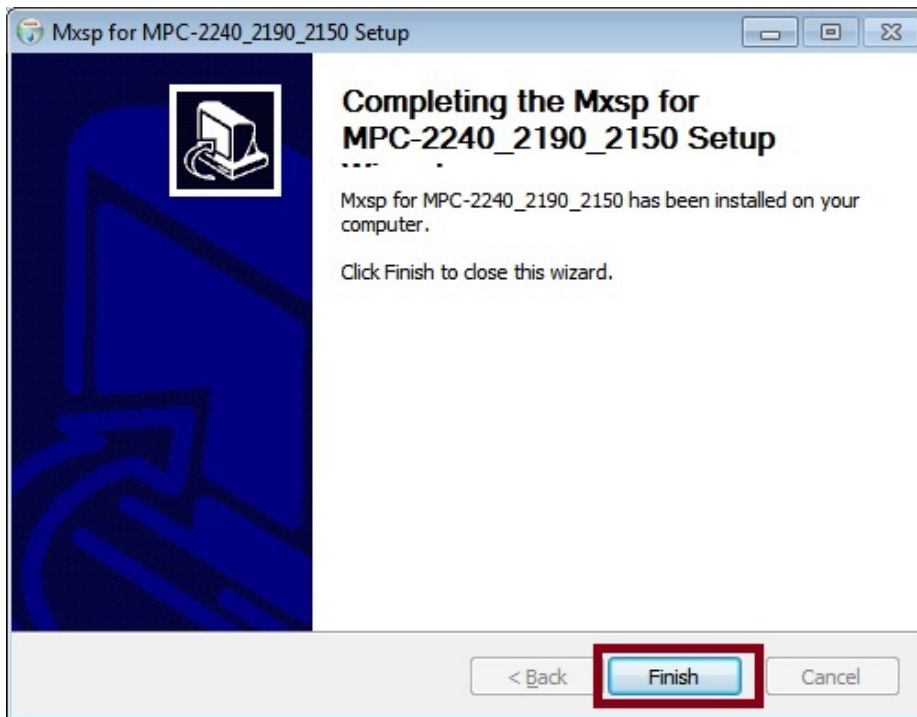

Configuring the Serial Interface Mode

Complete the following steps to configure the interface mode:

1. From the Start menu, Click **All Programs** → **Moxa** → **mxSetSerialInterface**.

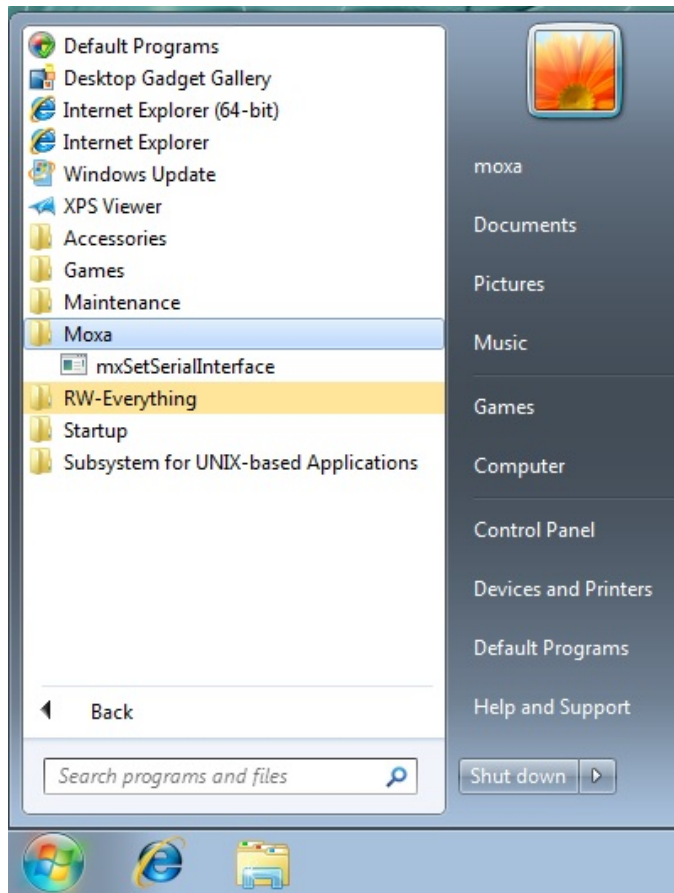

2. Select a port (COM1 or COM2).

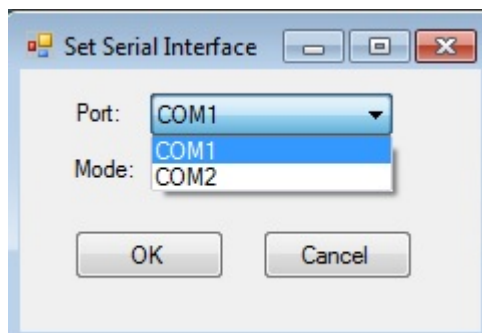

3. Select the mode that you want to use for the port selected in the previous step.

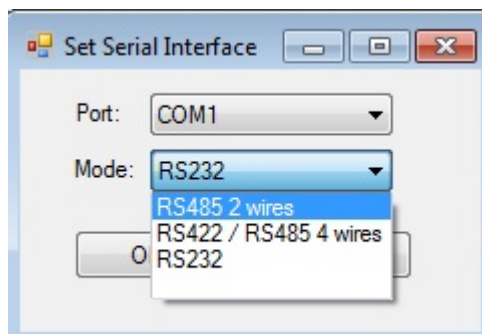

4. Click **OK**.

