



V2406/2422/2426 Series Quick Installation Guide

Third Edition, February 2014

Overview

The V2406/2422/2426 embedded computers are based on the Intel Atom N270 x86 processor, and feature four RS-232/422/485 serial ports, dual 10/100 Mbps LAN ports for the V2406/V2426 (dual 10/100/1000 Mbps LAN ports for the V2422), 3 USB 2.0 hosts for the V2406/V2426 (6 for the V2422) and a CompactFlash socket. The V2406/2422/2426 computers provide VGA and DVI-I outputs, making it particularly well-suited for industrial applications such as rolling stock, SCADA, and automation systems.

Package Checklist

Before installing, verify that the package contains the following items:

- V2406/2422/2426 embedded computer
- Terminal block to power jack converter (V2422 only)
- PS2 to KB/MS Y-type cable
- Wall Mounting Kit.
- Quick Installation Guide.
- Document & Software DVD.
- Product Warranty Statement (printed)

NOTE: Please notify your sales representative if any of the above items are missing or damaged.

V2406/2422/2426 Panel Layout

V2406 Front View

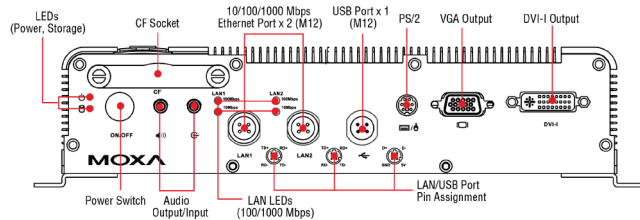

V2406 Rear View

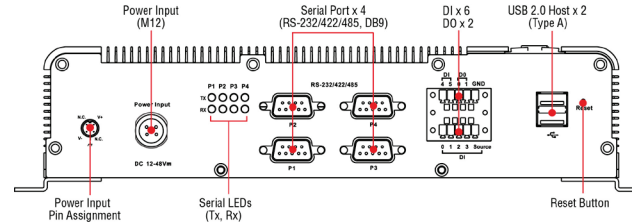

V2422 Front View

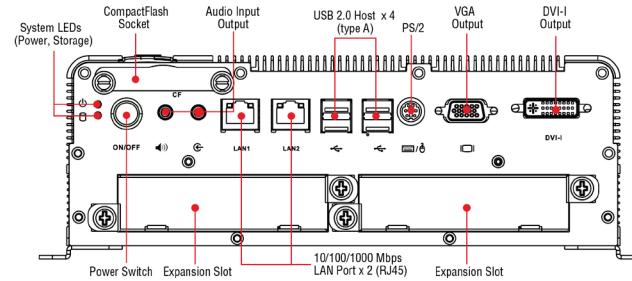

V2422 Rear View

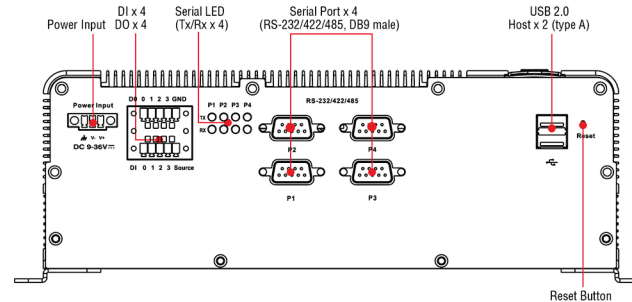

V2426 Front View

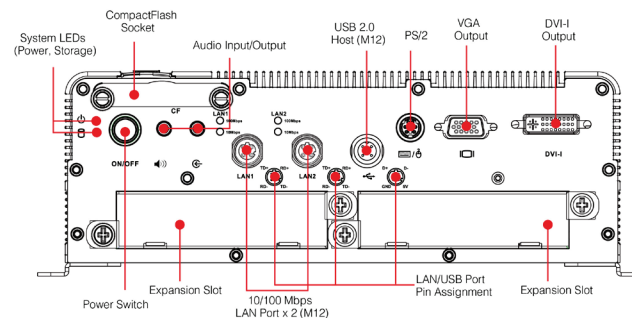

V2426 Rear View

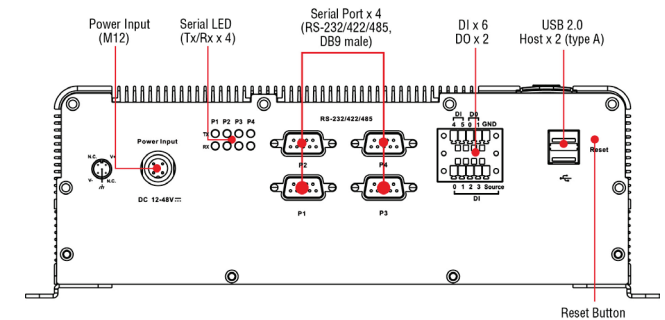

LED Indicators

The following table describes the LED indicators located on the front and rear panels of the V2406/2422/2426.

LED Name	LED Color	LED Function
Power	Green	Power is on and functioning normally
	Off	Power is off or power error exists
Storage	Yellow	CF/HDD card is detected
	Off	CF/HDD card is not detected
LAN (1, 2)	Green	10 (100 for V2422)Mbps Ethernet mode
	Yellow	100 (1000 for V2422) Mbps Ethernet mode
	Off	No activity or 10 Mbps Ethernet mode
Tx, Tx (P1-P4)	Green	Serial ports P1-P4 transmitting data
	Off	Serial ports P1-P4 not transmitting data
Rx, Rx (P1-P4)	Yellow	Serial ports P1-P4 receiving data
	Off	Serial ports P1-P4 not receiving data

Installing the V2406/2422/2426

The V2406/2422/2426 can be DIN-rail mounted, wall mounted, and VESA mounted. Some mounting kits may need to be purchased separately. Refer to the Hardware User's Manual for detailed installation instructions.

Connector Description

Power Connector

Connect the 12 to 48 VDC (9 to 36 VDC for the V2422) LPS or Class 2 power line to the V2406/2426's M12 power connector, and to the V2422's terminal block connector. If the power is supplied properly, the Power LED will light up. The OS is ready when the Ready LED glows a solid green.

Grounding the V2406/2422/2426

Grounding and wire routing help limit the effects of noise due to electromagnetic interference (EMI). Run the ground connection

P/N: 180202400012

from the ground screw to the grounding surface prior to connecting the power. Please note that these products are intended to be mounted to a well-grounded mounting surface, such as a metal panel

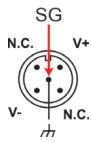

V2406/V2426

SG: The Shielded Ground (sometimes called Protected Ground) contact is the central pin of the power input connector. Connect the SG wire to an appropriate grounded metal surface.

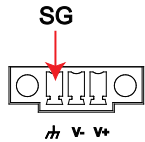

V2422

SG: The Shielded Ground (sometimes called Protected Ground) contact is the left-most pin of the power input connector. Connect the SG wire to an appropriate grounded metal surface.

VGA and DVI Outputs

The V2406/2422/2426 comes with a D-Sub 15-pin female connector for a VGA monitor; it also comes with a DVI-I connector for the DVI display. These output interfaces are all located on the front panel. Use the proper cable to connect.

PS/2 Port

The V2406/2422/2426 embedded computer comes with a PS/2 mini-DIN connector to connect to a PS/2 keyboard and PS/2 mouse. Use the Y-type cable to convert the mini-DIN connector into two 6-pin mini-DIN connectors to connect both a PS/2 keyboard and PS/2 mouse at the same time. You may also use the USB ports to connect your USB-based keyboard and mouse. Please note that without a Y-type cable, the PS/2 connector on the V2406/2422/2426 can only work with a PS/2 keyboard. A PS/2 mouse will not function when directly connected to the PS/2 connector on the V2406/2422/2426 embedded computer.

CompactFlash Slot

The V2406/2422/2426 has a CompactFlash slot located on the front panel for storage expansion. It supports CF Type-I/II with DMA mode. To install a CompactFlash card, remove the outer cover, and then insert the CF card in the socket. When finished, push the cover into the socket and fasten the screws.

USB Hosts

The V2406/2426 has one USB port with an M12 connector on the front panel, and two USB ports with type A connectors on the rear panel. For the V2422, four USB ports are located on the front panel, two on the rear panel, and all come with type A connectors. These USB ports can be used to connect flash disks for storing large amounts of data.

Expansion Module Slot

The V2422/V2426 comes with two expansion slots that can connect different communication modules, such as a 2-port CAN

module, a wireless communication module, an 8-DI/8-DO module, and a 2-port serial module.

Ethernet Ports

V2406/2426

Two 10/100 Mbps Ethernet ports using M12 connectors are located on the front panel. See the following pin assignments.

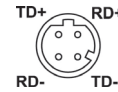

V2422

Two 10/100/1000 Mbps Ethernet ports with RJ45 connectors are located on the front panel. See the following pin assignments.

PIN	10/100 Mbps	10/100/1000 Mbps
1	ETx+	TRD(0)+
2	ETx-	TRD(0)-
3	ERx+	TRD(1)+
4		TRD(2)+
5		TRD(2)-
6	ERx-	TRD(1)-
7		TRD(3)-
8		TRD(3)+

Serial Ports

The serial ports use DB9 connectors. Each port can be configured by software for RS-232, RS-422, or RS-485. The pin assignments for the ports are shown in the following table:

Pin	RS-232	RS-422	RS-485 (4-wire)	RS-485 (2-wire)
1	DCD	TxDA(-)	TxDA(-)	-
2	RxD	TxDB(+)	TxDB(+)	-
3	TxD	RxDB(+)	RxDB(+)	DataB(+)
4	DTR	RxDA(-)	RxDA(-)	DataA(-)
5	GND	GND	GND	GND
6	DSR	-	-	-
7	RTS	-	-	-
8	CTS	-	-	-

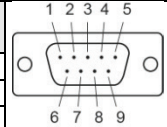

DI/DO

The V2406/2426 comes with a 6-ch digital input and 2-ch digital output (4 DI/4 DO for V2422) in the terminal block connectors.

Audio Interface

The V2406/2422/2426 comes with an audio input and an audio output, allowing users to connect a speaker or an earphone

Reset Button

Press the "Reset Button" on the rear panel of the computers to reboot the system automatically. The Ready LED will blink on and off for the first 5 seconds, and then maintain a steady glow once the system has rebooted.

Real-time Clock

The V2406/2422/2426's real-time clock is powered by a lithium battery. We strongly recommend that you do not replace the lithium battery without help from a qualified Moxa support engineer. If you need to change the battery, contact the Moxa RMA

service team. **Please note that there is a risk of explosion if the battery is replaced by an incorrect type of battery.**

Powering on the V2406/2422/2426

To power on the V2406/2426, connect the power cable to the V2406/2426's M12 power connector (located at the rear panel). For the V2422, connect the power cable to the terminal block connector (located at the rear panel). Press the power button to turn on the computer. Note that the Shielded Ground wire should be connected to the central pin of the connector. It takes about 30 seconds for the system to boot up. Once the system is ready, the Power LED will light up.

Configuring the Ethernet Interface

Linux users should follow these steps:

Enter the following commands to edit the interfaces file:

```
#ifdown -a
//Disable LAN1/LAN2 interface first, before you
reconfigure the LAN settings. LAN 1 = eth0, LAN 2= eth1,
#vi /etc/network/interfaces
//check the LAN interface first//
```

After the boot settings of the LAN interface have been modified, use the following command to activate the LAN settings immediately:

```
#sync; ifup -a
```

XPE users should follow these steps.

1. Go to **Start** → **Network Connections**.
2. Right-click **Network Connections**, click **Properties**, select **Internet Protocol (TCP/IP)**, and then click **Properties**.
3. Click **OK** after inputting the proper IP address and netmask.

W7E users should follow these steps:

1. Go to **Start** -> **Control Panel**-> **Network and Internet** -> **View network status and tasks** -> **Change adapter setting**.
2. In the screen of Local Area Connection Properties, click **Internet Protocol (TCP/IP)** and then select **Properties**. Select **Internet Protocol Version 4**, and then click **Properties**.
3. Click **OK** after inputting the proper IP address and netmask.

MOXA® www.moxa.com/support

The Americas: +1-714-528-6777 (toll-free: 1-888-669-2872)
 Europe: +49-89-3 70 03 99-0
 Asia-Pacific: +886-2-8919-1230
 China: +86-21-5258-9955 (toll-free: 800-820-5036)

© 2014 Moxa Inc., All Rights Reserved