

AWK-3251A-M12-RCC Series Quick Installation Guide

Moxa AirWorks

Version 1.0, August 2023

Technical Support Contact Information
www.moxa.com/support

MOXA[®]

© 2023 Moxa Inc. All rights reserved.

P/N: 1802032510010



Overview

The AWK-3251A-M12-RCC Series is an industrial-grade AP/Client with IEEE 802.11ac technology. This Series features concurrent dual-band Wi-Fi data transmissions up to 400 Mbps (2.4 GHz mode) and 867 Mbps (5 GHz mode), meeting the speed and flexibility requirements for industrial applications. In addition, the built-in dual band pass filter and the wide-temperature design ensure reliability and continuous operation in harsh environments. The dual redundant DC power inputs enhance availability while PoE support provides more flexibility for powering end devices and simplifying field-site deployments.

Hardware Setup

This section covers the hardware setup for the AWK-3251A-M12-RCC.

Package Checklist

Moxa's AWK-3251A-M12-RCC is shipped with the following items. If any of these items is missing or damaged, please contact your customer service representative for assistance.

- 1 x AWK-3251A-M12-RCC wireless AP/Client
- DIN-rail kit
- Cable holder with one screw
- Quick installation guide (printed)
- Warranty card

Optional Mounting Accessories (Sold Separately)

- Wall-mount kit including 6 screws (M3x6)

Panel Layout of the AWK-3251A-M12-RCC Series

Top Panel View

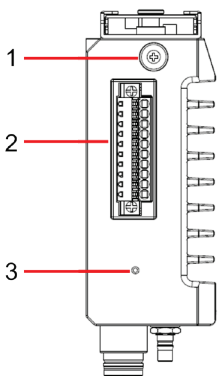

Rear Panel View

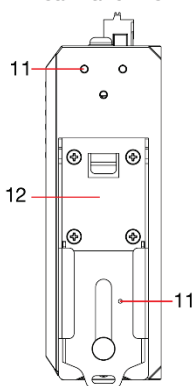

Front Panel View

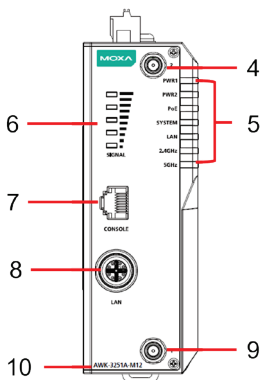

Bottom Panel View

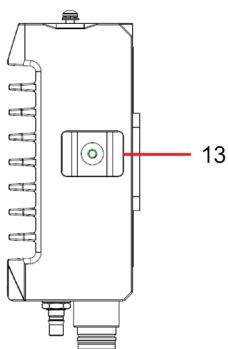

- | | |
|--|--|
| <ol style="list-style-type: none"> 1. Grounding screw (M5) 2. Terminal blocks for PWR1, PWR2, relay, DI 1 and DI 2 3. Reset button 4. Antenna connector 2 5. System LEDs: PWR1, PWR2, PoE, SYSTEM, LAN, 2.4GHz, 5GHz 6. Signal strength indicator 7. Console port (RS-232, RJ45) 8. 10/100/1000BaseT(X) M12 LAN port 9. Antenna connector 1 10. Model name | <ol style="list-style-type: none"> 11. Screw holes for wall-mounting kit 12. DIN-rail mounting kit 13. Cable holder screw |
|--|--|

Mounting Dimensions

Unit: mm (inch)

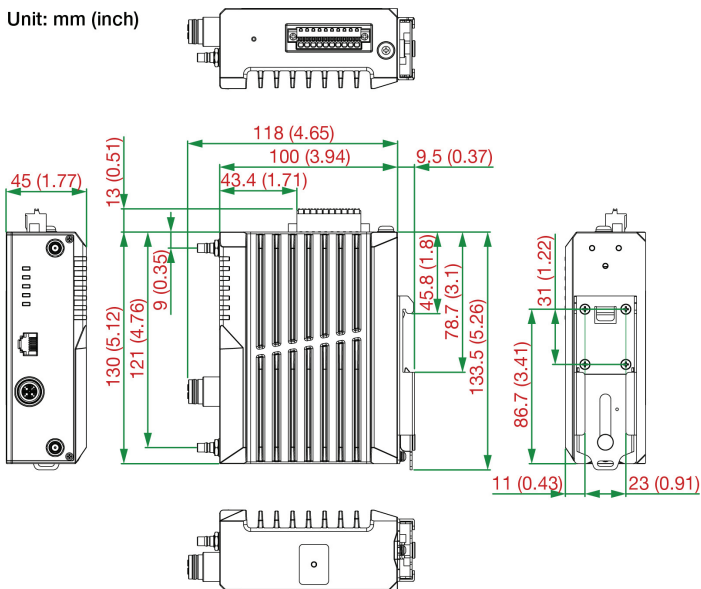

DIN-rail Mounting

When shipped, the metal DIN-rail mounting kit is pre-installed on the back panel of the AWK-3251A-M12-RCC with four M3 (M3x6mm) screws. Mount the AWK-3251A-M12-RCC onto a corrosion-free mounting rail that adheres to the EN 60715 standard.

STEP 1:

Insert the upper lip of the DIN-rail mounting kit into the mounting rail.

STEP 2:

Press the AWK-3251A-M12-RCC towards the mounting rail until it snaps into place.

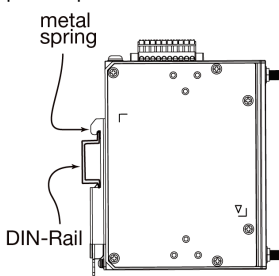
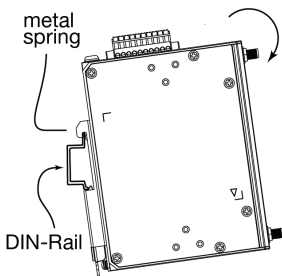

To remove the AWK-3251A-M12-RCC from the DIN rail, do the following:

STEP 1:

Pull down the latch on the DIN-rail kit with a screwdriver.

STEP 2 & 3:

Slightly pull the AWK-3251A-M12-RCC forward and lift it up to remove it from the mounting rail.

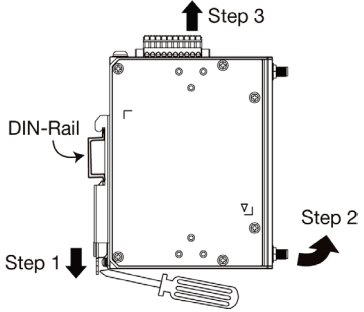

Wall Mounting

For some applications, it may be more convenient to mount the AWK-3251A-M12-RCC to a wall. The device can be mounted either sideways or frontally.

Option 1: Wall-mounting plates on the side

STEP 1:

Remove the aluminum DIN-rail attachment plate from the AWK-3251A-M12-RCC, and then attach the wall-mounting plates with six M3x5mm screws, as shown in the following diagram.

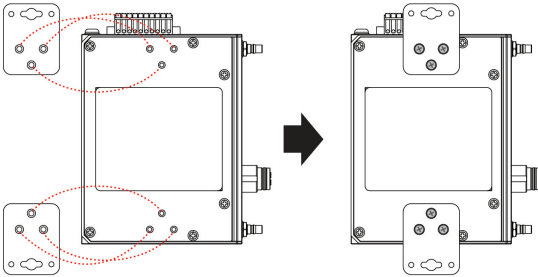

STEP 2:

Mounting the AWK-3251A-M12-RCC to a wall requires 2 screws. Use the AWK-3251A-M12-RCC device, with wall-mounting plates attached, as a guide to mark the correct locations of the 2 screws on the wall. The heads of the screws should be less than 6.0 mm in diameter, the shafts should be less than 3.5 mm in diameter, and the screw length should be at least 15 mm, as shown in the figure on the right.

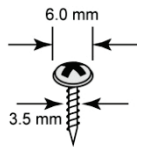

Do not drive the screws in all the way—leave a space of about 2 mm to allow room for sliding the wall-mounting panel between the wall and the screws.

NOTE Test the screw head and shank size by inserting the screws into one of the keyhole shaped apertures of the wall-mounting plates before they are fixed to the wall.

STEP 3:

Once the screws are fixed into the wall, insert the four screw heads through the large opening of the keyhole-shaped apertures, and then slide the AWK-3251A-M12-RCC downwards, as shown in the diagram below. Tighten the two screws for added stability.

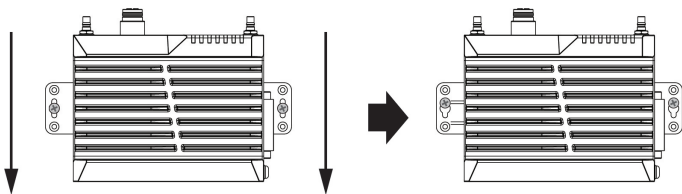

Option 2: Wall-mounting plates on the rear

STEP 1:

Remove the aluminum DIN-rail attachment plate from the AWK-3251A-M12-RCC, and then attach the wall-mounting plates with six M3x5mm screws, as shown in the following diagram.

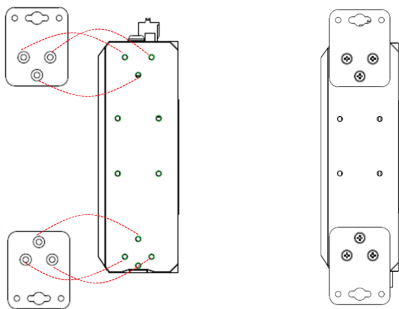

STEP 2:

Mounting the AWK-3251A-M12-RCC to a wall requires 2 screws. Use the AWK-3251A-M12-RCC device, with wall-mounting plates attached, as a guide to mark the correct locations of the 2 screws on the wall. The heads of the screws should be less than 6.0 mm in diameter, the shafts should be less than 3.5 mm in diameter, and the screw length should be at least 15 mm, as shown in the figure on the right.

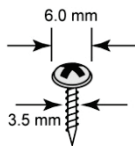

Do not drive the screws in all the way—leave a space of about 2 mm to allow room for sliding the wall-mounting panel between the wall and the screws.

NOTE Test the screw head and shank size by inserting the screws into one of the keyhole shaped apertures of the wall-mounting plates before they are fixed to the wall.

STEP 3:

Once the screws are fixed into the wall, insert the four screw heads through the large opening of the keyhole-shaped apertures, and then slide the AWK-3251A-M12-RCC downwards, as shown in the diagram below. Tighten the two screws for added stability.

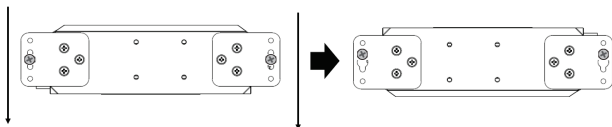

WARNING

- This equipment is intended to be used in a Restricted Access Location, such as a dedicated computer room where only authorized service personnel or users can gain access. Such personnel must be instructed about the fact that the metal chassis of the equipment is extremely hot and may cause burns.
- Service personnel or users have to pay special attention and take special precautions before handling this equipment.
- Only authorized, well-trained professionals should be allowed to access the restricted access location. Access should be controlled by the authority responsible for the location with lock and key or a security identity system.
- **External metal parts are hot!!** Pay special attention or use special protection before handling the equipment.

Wiring Requirements



WARNING

Safety First!

Be sure to disconnect the power cord before installing and/or wiring your AWK-3251A-M12-RCC.

Calculate the maximum possible current in each power wire and common wire. Observe all electrical codes that dictate the maximum current allowed for each wire size. If the current goes above the maximum ratings, the wiring could overheat, causing serious damage to your equipment.

Read and Follow These Guidelines:

- Use separate paths to route wiring for power and devices. If power wiring and device wiring paths must cross, make sure the wires are perpendicular at the crossing point.

NOTE Do not run signal or communications wiring and power wiring in the same wire conduit. To avoid interference, wires with different signal characteristics should be routed separately.

- You can use the type of signal transmitted through a wire to determine which wires should be kept separate. The rule of thumb is that wiring that shares similar electrical characteristics can be bundled together.
- Keep input wiring and output wiring separated.
- For future reference, you should label the wiring used for all of your devices.

NOTE If the device is powered by PoE, the PSE equipment and cabling should not be connected to outside facilities.

NOTE The product is intended to be supplied by a UL Listed Power Unit marked "L.P.S." (or "Limited Power Source") and is rated 1) 12-48 VDC, 2.01-0.5 A min. (supplied by power adapter) or 48 VDC, 0.48 A min. (supplied by PoE), Tma = 75 degree C. If you need further assistance with purchasing the power source, please contact Moxa for further information.

NOTE If using a Class I adapter, the power cord must be connected to a socket-outlet with an earthing connection.



ATTENTION

Make sure the external power adapter (includes power cords and plug assemblies) provided with the unit is certified and suitable for use in your country or region.



ATTENTION

DO NOT use a PoE Injector. Instead, use an IEEE 802.3af or IEEE 802.3at compliant PSE (Power Sourcing Equipment) for PoE (Power over Ethernet) devices.



ATTENTION

The USB interface is coded to only support Moxa's ABC-02 dongle for troubleshooting or debugging purposes.

NOTE This product can be deployed on vehicles as the control unit's wireless interface that collects data from different I/O devices and transmits the data to vehicle dispatch centers.

Grounding the AWK-3251A-M12-RCC

Grounding and wire routing help limit the effects of noise due to electromagnetic interference (EMI). Run the ground connection from the ground screw to the grounding surface prior to connecting devices.



ATTENTION

This product is intended to be mounted to a well-grounded mounting surface, such as a metal panel. The potential difference between any two grounding points must be zero. If the potential difference is NOT zero, the product could be permanently damaged.

Installations with Cable Extended Antennas for Outdoor Applications

If an AWK device or its antenna is installed in an outdoor location, proper lightning protection is required to prevent direct lightning strikes to the AWK device. To prevent the effects of coupling currents from nearby lightning strikes, a lightning arrester should be installed as part of your antenna system. Ground the device, antenna, as well as the arrester properly to provide maximum outdoor protection for the device.

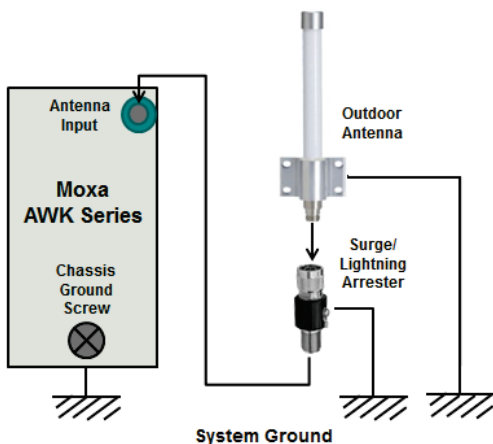

Arrester Accessories

- **SA-NMNF-02:** Surge arrester, N-type (male) to N-type (female)
- **SA-NFNF-02:** Surge arrester, N-type (female) to N-type (female)

Terminal Block Pin Assignment

The AWK-3251A-M12-RCC comes with a 10-pin terminal block located on the top panel of the device. The terminal block contains dual power inputs, a relay output, and dual digital inputs. Refer to the following figure and table for the detailed pin assignment.

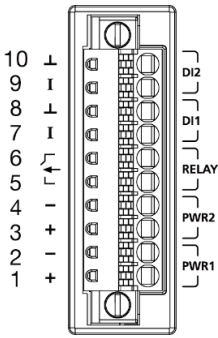

Pin	Definition
1	DC Power Input 1
2	
3	DC Power Input 2
4	
5	Relay Output
6	
7	Digital Input 1
8	Digital Input GND
9	Digital Input 2
10	Digital Input GND

Wiring the Redundant Power Inputs

The first two pairs of contacts of the 10-contact terminal block connector on the AWK-3251A-M12-RCC's top panel are used for the AWK-3251A-M12-RCC's two DC inputs. The top view of the terminal block connector is shown below.

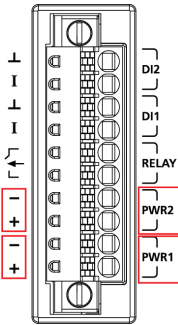

STEP 1: Insert the negative/positive DC wires into the +/- terminals.

STEP 2: Insert the plastic terminal block connector prongs into the terminal block receptor, which is located on the AWK-3251A-M12-RCC's top panel.

NOTE Before connecting the AWK-3251A-M12-RCC's DC power inputs, make sure the DC power source voltage is stable.

- The wiring for the input terminal block shall be installed by a skilled person.
- Wire type: Cu
- Only use 16-22 AWG wire size.
- Use only one conductor in a clamping point between the DC power source and the power input.



ATTENTION

If the AWK-3251A-M12-RCC is connected to a motor or other similar type of equipment, be sure to use power isolation protection. Before connecting the AWK-3251A-M12-RCC to the DC power inputs, make sure the DC power source voltage is stable.

Wiring the Relay Contact

The AWK-3251A-M12-RCC has one relay output, which consists of two contacts on the terminal block on the AWK-3251A-M12-RCC's top panel. Refer to the **Wiring the Redundant Power Inputs** section for detailed instructions on how to connect the wires to the terminal block connector, and how to attach the terminal block connector to the terminal block receptor. These relay contacts are used to indicate user-configured events. The two wires attached to the Relay contacts form an open circuit when a user-configured event is triggered. If a user-configured event does not occur, the Relay circuit will be closed.

Wiring the Digital Inputs

The AWK-3251A-M12-RCC has two sets of digital inputs—DI1 and DI2. Each DI has two contacts on the 10-pin terminal block connector on the AWK-3251A-M12-RCC's top panel. Refer to the **Wiring the Redundant Power Inputs** section for detailed instructions on how to connect the wires to the terminal block connector, and how to attach the terminal block connector to the terminal block receptor.

Cable Holder Installation

Attach the cable holder to the bottom of the AWK-3251A-M12-RCC to keep cabling neat and avoid accidents that result from untidy cables.

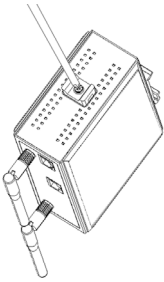

STEP 1: Screw the cable holder onto the bottom of the AWK-3251A-M12-RCC.

STEP 2: After mounting the AWK-3251A-M12-RCC and plugging in the LAN cable, tighten the cable along the device and wall.

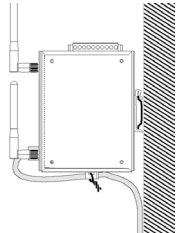
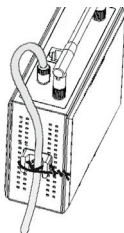
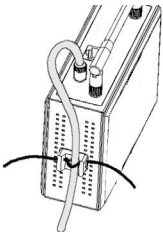

Communication Connections

10/100/1000BaseT(X) Ethernet Port Connection

The 10/100/1000BaseT(X) ports located on the AWK-3251A-M12-RCC's front panel are used to connect to Ethernet-enabled devices.

MDI/MDI-X Port Pinouts

Pin	1000BaseT MDI/MDI-X	10/100BaseT (X) MDI	10/100BaseT (X) MDI-X
1	DA+	TD+	RD+
2	DA-	TD-	RD-
3	DB+	RD+	TD+
4	DB-	RD-	TD-
5	DD+	-	-
6	DD-	-	-
7	DC-	-	-
8	DC+	-	-

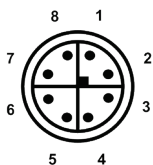

RS-232 Connection

The AWK-3251A-M12-RCC has one RS-232 (8-pin RJ45) console port located on the front panel. Use either an RJ45-to-DB9 or RJ45-to-DB25 cable to connect the AWK-3251A-M12-RCC's console port to your PC's COM port. You may then use a console terminal program to access the AWK-3251A-M12-RCC for console configuration.

Pin	Description
1	DSR
2	NC
3	GND
4	TXD
5	RXD
6	NC
7	NC
8	DTR

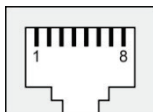

LED Indicators

The front panel of the AWK-3251A-M12-RCC feature several LED indicators. The function of each LED is described in the table below:

LED	Color	State	Description
Front Panel LED Indicators (System)			
PWR1	Green	On	Power is being supplied from power input 1.
		Off	Power is not being supplied from power input 1.
PWR2	Green	On	Power is being supplied from power input 2.
		Off	Power is not being supplied from power input 2.
PoE	Amber	On	Power is being supplied via PoE.
		Off	Power is not being supplied via PoE.
SYS	Red	On	System initialization failure, configuration error, or system error.

LED	Color	State	Description
	Green	On	System startup completed and is operating normally.
LAN	Green	On	LAN port's 1000 Mbps link is active.
		Blinking (3 Hz)	Data is being transmitted at 1000 Mbps.
		Off	LAN port's 1000 Mbps link is inactive.
	Amber	On	LAN port's 10/100 Mbps link is active.
		Blinking (3 Hz)	Data is being transmitted at 10/100 Mbps.
		Off	LAN port's 10/100 Mbps link is inactive.
2.4G	Green	On	The AWK is in Client-based mode (Client, Client-Router, ACC-Slave).
		Blinking	The AWK is in Client-based mode and is transmitting traffic.
	Amber	On	The AWK is in AP-based mode (AP, Master, ACC-Master).
		Blinking	Data is being transmitted over the 2.4 GHz band.
	Green/Amber	Off	The WLAN is in Client/Slave/ACC Master/ACC Slave mode without an established connection, or the WLAN is not working properly.
	5G	Green	On
Blinking			The AWK is in Client-based mode and is transmitting traffic.
Amber		On	The AWK is in AP-based mode (AP, Master, ACC-Master).
		Blinking	Data is being transmitted over the 5 GHz band.
Green/Amber		Off	The WLAN is in Client/Slave/ACC Master/ACC Slave mode without an established connection, or the WLAN is not working properly.
Signal Strength (5 LEDs)		Green	On
	Off		The AWK is in AP/Master/Sniffer mode, or no connection is established.

Specifications

Input Current	2.01 A @ 12 VDC, 0.5 A @ 48 VDC
Input Voltage	12 to 48 VDC, redundant dual power inputs, 48 VDC Power over Ethernet
Power Consumption	24.12 W (max.)
Relay Output	24 VDC, 1 A (resistive load)
Operating Temperature	Standard Models: -25 to 60°C (-13 to 140°F) Wide Temp. Models: -40 to 75°C (-40 to 167°F)
Storage Temperature	-40 to 85°C (-40 to 185°F)

NOTE To meet the standard for IP30 protection, all unused ports should be covered with the protective caps.



ATTENTION

The AWK-3251A-M12-RCC is NOT a portable mobile device and should be located at least 20 cm away from the human body.

The AWK-3251A-M12-RCC is NOT designed for the general public. To ensure that your AWK-3251A-M12-RCC wireless network is safe and configured correctly, consult a well-trained technician to assist with the installation process.



ATTENTION

Use the appropriate antennas for your wireless setup: Use 2.4 GHz antennas when the AWK-3251A-M12-RCC is configured for IEEE 802.11b/g/n. Use 5 GHz antennas when the AWK-3251A-M12-RCC is configured for IEEE 802.11a/n/ac. Make sure that the antennas are located in an area with a lightning and surge protection system installed.



ATTENTION

Do not locate the antenna near overhead power lines or other electric light or power circuits, or where it can come into contact with such circuits. When installing the antenna, take extreme care not to come into contact with such circuits, because they may cause serious injury or death. For proper installation and grounding of the antenna, refer to national and local codes (for example, U.S.: NFPA 70; National Electrical Code (NEC) Article 810; Canada: Canadian Electrical Code, Section 54).

NOTE For installation flexibility, you can use either antenna 1 or antenna 2. Make sure the antenna connection matches the antennas configured in the AWK-3251A-M12-RCC's web interface.

To protect the connectors and RF module, all radio ports should be terminated by either an antenna or a terminator. We strongly recommend using resistive terminators for terminating the unused antenna ports.

Software Setup

This section covers the software setup for the AWK-3251A-M12-RCC.

How to Access the AWK

Before installing the AWK device (AWK), make sure that all items in the package checklist are provided in the product box. You will also need access to a notebook computer or PC equipped with an Ethernet port.

- **Step 1: Select a suitable power source and plug in the AWK.**
The AWK can be powered by DC power ranging from **12 VDC to 48 VDC** or by a **PoE PSE** via an Ethernet connection.
- **Step 2: Connect the AWK to the notebook or PC via the AWK's LAN port.**

The LED indicator on the AWK's LAN port will light up when a connection is established.



NOTE If you are using an Ethernet-to-USB adapter, follow the instructions in the user's manual provided with the adapter.

- **Step 3: Set up the computer's IP address.**

Choose an IP address for the computer that is on the same subnet as the AWK. Since the AWK's default IP address is **192.168.127.253**, and the subnet mask is **255.255.255.0**, set the IP address to **192.168.127.xxx**, where **xxx** is a value between 1 and 252.

- **Step 4: Access the homepage of the AWK.**

Open your computer's web browser and type **https://192.168.127.253** in the address field to access the AWK's homepage. If successfully connected, the AWK's interface homepage will appear. Click **NEXT**.

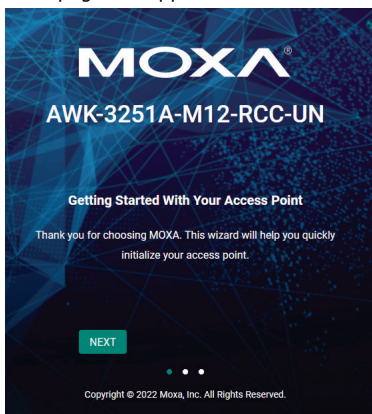

- **Step 5: Choose your country or region.**

Select your country or region from the drop-down list and click **NEXT**.

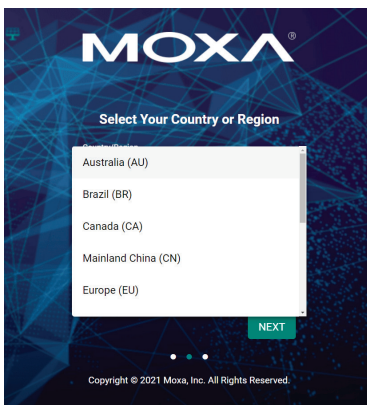

- **Step 6: Create a user account and password.**

Enter the username, password, and email address for your user account and click **CREATE**.

NOTE The username and password are case-sensitive.

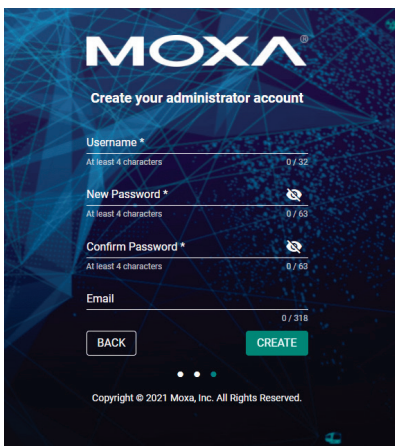

After creating your account, you will be automatically redirected to the login screen.

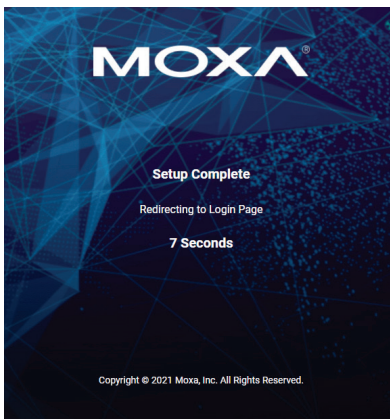

- **Step 7: Log in to the device.**

Enter your username and password and click **LOG IN**. The device will start initializing, this may take several seconds. Once the warning message has disappeared, you can log in using your username and password.



First-time Quick Configuration

After successfully accessing the AWK, refer to the appropriate subsection below to quickly set up a wireless network.

NOTE Ensure that there are no IP address conflicts when you configure more than one AWK on the same subnet.

AP/Client Mode

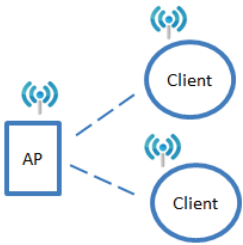

Configuring the AWK as an AP

- **Step 1: Set the operation mode of the AWK to AP mode.**

Go to **Wi-Fi** → **Wireless Settings** and select **AP** from the Operation Mode drop-down list.

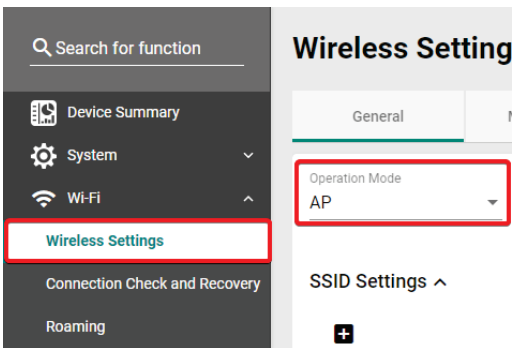

- **Step 2: Set up the AWK as an AP.**

Click the **ADD** icon to create a new SSID.

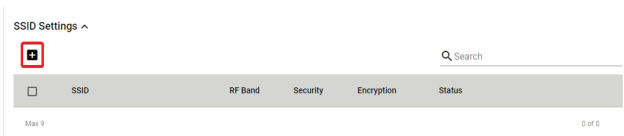

On the settings page, configure the **SSID Status**, **SSID**, **RF Band**, **RTS/CTS Threshold**, and **Transmission Rate** for the 5 GHz or 2.4 GHz band. When finished, click **NEXT**.

Configure SSID Settings

1 2

SSID Status *
Enabled

SSID *
MOXA

RF Band
5 GHz

At least 1 character 4 / 32

RTS / CTS Threshold
2346

32 - 2346 byte

Transmission Rate: 5 GHz

Data Transmission Rate
Auto

Min. Data Transmission Rate
0

0 - 54 Mbps

Broadcast/Multicast Data Trans...
36 Mbps

Management Transmission Rate
36 Mbps

CANCEL **NEXT**

On the second SSID Settings screen, configure the **SSID Broadcast Status** and **Security** type. From here, you can also copy the configuration over to the second SSID. When finished, click **CONFIRM**.

Configure SSID Settings

1 2

SSID Broadcast Status *
Enabled

Security
Open

Copy Config to SSIDs i

BACK **CONFIRM**

Configuring the AWK as a Client

- **Step 1: Set the operation mode of the AWK to Client mode.**

Go to **Wi-Fi** → **Wireless Settings** and select **Client** from the Operation Mode drop-down list, set the SSID, and click **Apply**. For more detailed configurations, refer to the **AWK-3251A-M12-RCC User Manual**.

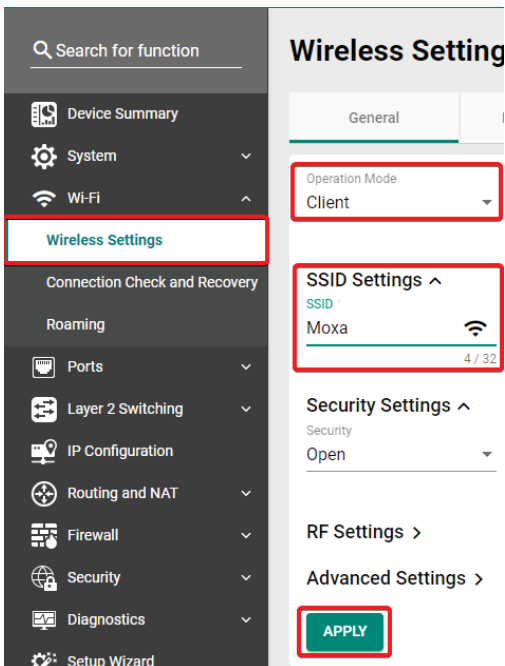

Master/slave Mode

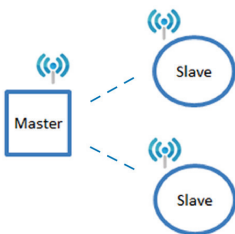

Configuring the AWK as a Master

- **Step 1: Set the operation mode of the AWK to Master mode.**

Go to **Wi-Fi** → **Wireless Settings** and select **Master** from the Operation Mode drop-down list.

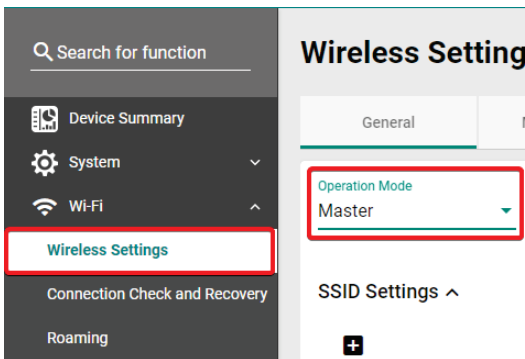

- **Step 2: Set up the AWK as a Master.**

Click the **ADD** icon  to create a new SSID.

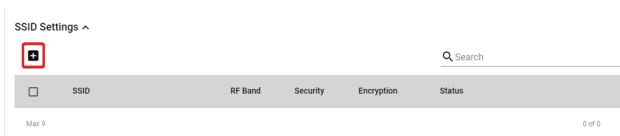

On the settings page, configure the **SSID Status, Master/AP** (select Master), **SSID, RF Band, RTS/CTS Threshold**, and **Transmission Rate** for the 5 GHz or 2.4 GHz band. When finished, click **NEXT**.

Configure SSID Settings

1 _____ 2

SSID Status *
Enabled Master / AP
Master

SSID * RF Band
MOXA 5 GHz

At least 1 character 4 / 32

RTS / CTS Threshold
2346

32 - 2346 byte

Transmission Rate: 5 GHz

Data Transmission Rate Min. Data Transmission Rate
Auto 0

0 - 54 Mbps

Broadcast/Multicast Data Trans... Management Transmission Rate
36 Mbps 36 Mbps

CANCEL NEXT

On the second SSID Settings screen, configure the **SSID Broadcast Status** and **Security** type. From here, you can also copy the configuration over to the second SSID. When finished, click **CONFIRM**.

Configure SSID Settings

SSID Broadcast Status *
Enabled

Security
Open

Copy Config to SSIDs ⓘ

BACK CONFIRM

Configuring the AWK as a Slave

- **Step 1: Set the operation mode of the AWK to Slave mode.**

Go to **Wi-Fi** → **Wireless Settings** and select **Slave** from the Operation Mode drop-down list, set the SSID, and click **Apply**. For more detailed configurations, refer to the **AWK-3251A-M12-RCC User Manual**.

Search for function

Device Summary

System

Wi-Fi

Wireless Settings

Connection Check and Recovery

Roaming

Ports

Layer 2 Switching

IP Configuration

Routing and NAT

Firewall

Security

Wireless Setting

General

Operation Mode
Slave

SSID Settings ^
SSID *
Moxa 4 / 32

Security Settings >

RF Settings >

Advanced Settings >

APPLY

Certifications

FCC/IC Statements

Federal Communication Commission Interference Statement

This equipment has been tested and found to comply with the limits for a Class A digital device, pursuant to Part 15 of the FCC Rules. These limits are designed to provide reasonable protection against harmful interference in a residential installation. This equipment generates, uses and can radiate radio frequency energy and, if not installed and used in accordance with the instructions, may cause harmful interference to radio communications.

However, there is no guarantee that interference will not occur in a particular installation. If this equipment does cause harmful interference to radio or television reception, which can be determined by turning the equipment off and on, the user is encouraged to try to correct the interference by one of the following measures:

- Reorient or relocate the receiving antenna.
- Increase the separation between the equipment and receiver.
- Connect the equipment into an outlet on a circuit different from that to which the receiver is connected.
- Consult the dealer or an experienced radio/TV technician for help.

Radio Transmitters (Part 15)

This device complies with part 15 of the FCC Rules. Operation is subject to the following two conditions:

1. This device may not cause harmful interference.
2. This device must accept any interference received, including interference that may cause undesired operation.

IMPORTANT NOTE

This device is restricted to mobile configuration. To comply with FCC RF exposure compliance requirements, the antenna used for this transmitter must be installed to provide a separation distance of at least 50 cm from all persons and must not be co-located or operating in conjunction with any other antenna or transmitter. This device must not be co-located or operating in conjunction with any other antenna or transmitter.

Canada, Innovation, Science and Economic Development Canada (ISED) Notices

This device contains licence-exempt transmitter(s)/receiver(s) that comply with Innovation, Science and Economic Development Canada's licence-exempt RSS(s). Operation is subject to the following two conditions:

This device may not cause interference.

This device must accept any interference, including interference that may cause undesired operation of the device.

1. The device for operation in the band 5150-5250 MHz is only for indoor use to reduce the potential for harmful interference to co-channel mobile satellite systems;

les dispositifs fonctionnant dans la bande 5 150-5 250 MHz sont réservés uniquement pour une utilisation à l'intérieur afin de réduire les risques de brouillage préjudiciable aux systèmes de satellites mobiles utilisant les mêmes canaux

2. This device is for indoor use only when operated in the frequency band 5250-5350 MHz.

Ce dispositif est limité à une utilisation en intérieur seulement dans la bande 5250-5350 MHz.

Radio Frequency (RF) Exposure Information

The radiated output power of the Wireless Device is below the Innovation, Science and Economic Development Canada (ISED) radio frequency exposure limits. The Wireless Device should be used in such a manner such that the potential for human contact during normal operation is minimized.

This device has also been evaluated and shown compliant with the ISED RF Exposure limits under mobile exposure conditions. (antennas are greater than 50 cm from a person's body).

Avis du Canada, Innovation, Sciences et Développement économique Canada (ISED)

L'émetteur/récepteur exempt de licence contenu dans le présent appareil est conforme aux CNR d'Innovation, Sciences et Développement économique Canada applicables aux appareils radio exempts de licence. L'exploitation est autorisée aux deux conditions suivantes :

- (1) L'appareil ne doit pas produire de brouillage;
- (2) L'appareil doit accepter tout brouillage radioélectrique subi, même si le brouillage est susceptible d'en compromettre le fonctionnement.

Informations concernant l'exposition aux fréquences radio (RF)

La puissance de sortie rayonnée du dispositif sans fil est inférieure aux limites d'exposition aux radiofréquences d'Innovation, Sciences et Développement économique Canada (ISED). Le dispositif sans fil doit être utilisé de manière à minimiser le potentiel de contact humain pendant le fonctionnement normal.

Cet appareil a également été évalué et montré conforme aux limites d'exposition RF ISED dans des conditions d'exposition mobiles. (Les antennes sont à plus de 50 cm du corps d'une personne).

NCC Statements

經型式認證合格之低功率射頻電機，非經許可，公司、商號或使用者均不得擅自變更頻率、加大功率或變更原設計之特性及功能。

低功率射頻電機之使用不得影響飛航安全及干擾合法通信；經發現有干擾現象時，應立即停用，並改善至無干擾時方得繼續使用。

前項合法通信，指依電信法規定作業之無線電通信。低功率射頻電機須忍受合法通信或工業、科學及醫療用電波輻射性電機設備之干擾。

應避免影響附近雷達系統之操作。

高增益指向性天線只得應用於固定式點對點系統。