

EDS-P510A-8PoE Series Quick Installation Guide

Moxa EtherDevice™ Switch

Edition 3.0, July 2017

Technical Support Contact Information **www.moxa.com/support**

Moxa Americas:

Toll-free: 1-888-669-2872

Tel: 1-714-528-6777

Fax: 1-714-528-6778

Moxa China (Shanghai office):

Toll-free: 800-820-5036

Tel: +86-21-5258-9955

Fax: +86-21-5258-5505

Moxa Europe:

Tel: +49-89-3 70 03 99-0

Fax: +49-89-3 70 03 99-99

Moxa Asia-Pacific:

Tel: +886-2-8919-1230

Fax: +886-2-8919-1231

Moxa India:

Tel: +91-80-4172-9088

Fax: +91-80-4132-1045

MOXA®

© 2017 Moxa Inc. All rights reserved.

P/N: 1802005100022



Overview

The Moxa EDS-P510A-8PoE series switches are Gigabit managed PoE+ Ethernet switches that come standard with eight 10/100BaseT(X), 802.3af (PoE) and 802.3at (PoE+) compliant Ethernet ports and two combo Gigabit Ethernet ports. The EDS-P510A-8PoE Ethernet switches provide up to 30 watts of power per PoE+ port in standard mode, and allow high power output of up to 36 watts for industrial heavy-duty PoE devices, such as weather-proof IP surveillance cameras with wipers/heaters, high-performance wireless access points, and rugged IP phones. The EDS-P510A-8PoE Ethernet switches are highly versatile, and the SFP fiber ports can transmit data up to 120 km from the device to the control center with high EMI immunity. The Ethernet switches support a variety of management functions, including STP/RSTP, TurboRing, Turbo Chain, PoE power management, PoE device auto-checking, PoE power scheduling, IGMP, VLAN, QoS, RMON, bandwidth management, and port mirroring. The EDS-P510A-8PoE series is designed especially for outdoor harsh environment applications with 3KV surge resistance to keep continuous reliability of the PoE systems.

Package Checklist

The EDS-P510A-PoE is shipped with the following items. If any of these items are missing or damaged, please contact your customer service representative for assistance.

- 1 EDS-P510A-8PoE EtherDevice Switch
- RJ45 to DB9 console port cable
- Protective caps for unused SFP ports
- DIN-Rail mounting kit (attached to the EDS-P510A-8PoE's rear panel by default)
- CD-ROM with user's manual and Windows utility
- Quick installation guide (printed)
- Warranty card

Panel Views of EDS-P510A-8PoE

Front Panel View

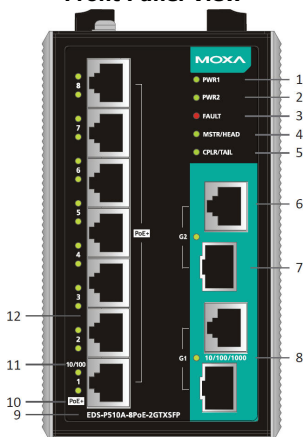

1. Power input PWR1 LED
2. Power input PWR2 LED
3. Fault LED
4. MSTR/HEAD LED
5. CPLR/TAIL LED
6. 100Mbps copper port of the combo port
7. 100/1000Mbps SFP port of the combo port
8. Gigabit port speed LED
9. Model name
10. SmartPoE LED indicator of PoE+ ports
11. Fast Ethernet port speed LED
12. 10/100Mbps IEEE 802.3af/at port

Top Panel View

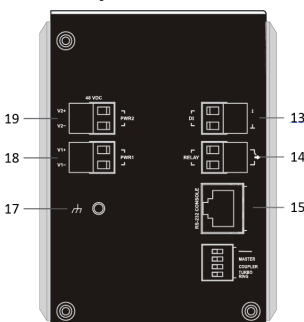

13. Terminal block for digital input
14. Terminal block for relay output
15. RS-232 serial console port
16. DIP switches
17. Grounding screw
18. Terminal block for power input 1
19. Terminal block for power input 2
20. Screw holes for wall mounting kit
21. DIN rail mounting kit
22. Heat dissipation vents

Rear Panel View

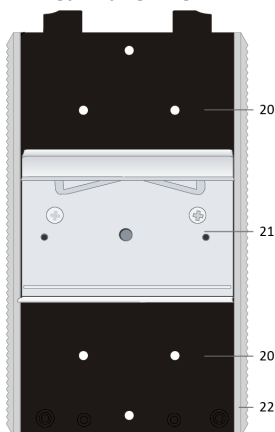

Mounting Dimensions (unit = mm)

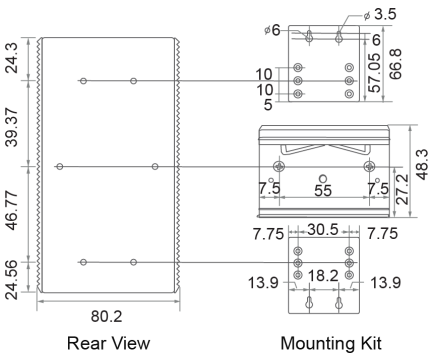
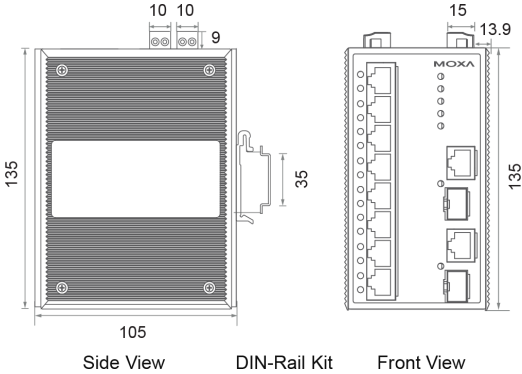

DIN-Rail Mounting

The aluminum DIN-Rail attachment plate should already be fixed to the back panel of the EDS-P510A-8PoE when you take it out of the box. If you need to reattach the DIN-Rail attachment plate to the EDS-P510A-8PoE, make sure the stiff metal spring is situated towards the top, as shown by the following figures.

STEP 1—Insert the top of the DIN-Rail into the slot just below the stiff metal spring.

STEP 2—The DIN-Rail attachment unit will snap into place as shown in the following illustration.

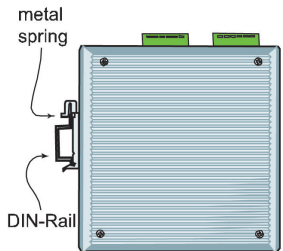
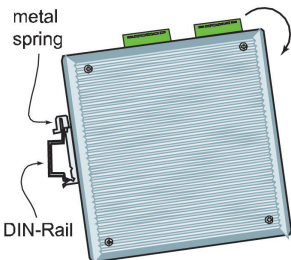

To remove the EDS-P510A-8PoE from the DIN-Rail, simply reverse Steps 1 and 2 above.

Wall Mounting (Optional)

For some applications, you will find it convenient to mount Moxa EDS-P510A-8PoE on the wall, as shown in the following illustrations:

STEP 1—Remove the aluminum DIN-Rail attachment plate from the rear panel of the EDS-P510A -8PoE, and then attach the wall mount plates with M3 screws, as shown in the figure at the right.

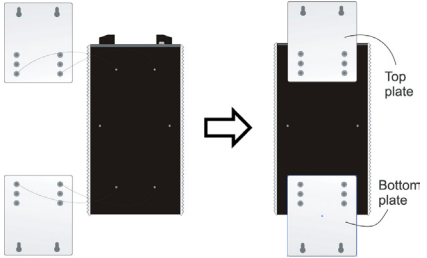

STEP 2—Mounting the EDS-P510A-8PoE on the wall requires 4 screws. Use the EDS-P510A-8PoE, with wall mount plates attached, as a guide to mark the correct locations of the 4 screws. The heads of the screws should be less than 6.0 mm in diameter, and the shafts should be less than 3.5 mm in diameter, as shown in the figure on at right.

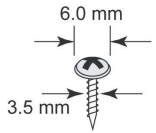

NOTE Before tightening the screws into the wall, make sure the screw head and shank size are suitable by inserting the screw through one of the keyhole-shaped apertures of the Wall Mounting Plates.

Do not screw the screws in all the way—leave about 2 mm to allow room for sliding the wall mount panel between the wall and the screws.

STEP 3—Once the screws are fixed to the wall, insert the four screw heads through the wide parts of the keyhole-shaped apertures, and then slide the EDS-P510A-8PoE downwards, as indicated in the figure at the right. Tighten the four screws for more stability.

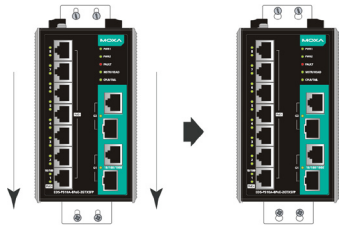

Wiring Requirements



WARNING

Do not disconnect modules or wires unless power has been switched off or the area is known to be non-hazardous. The devices may only be connected to the supply voltage shown on the type plate. The devices are designed for operation with a Safety Extra-Low Voltage. Thus, they may only be connected to the supply voltage connections and to the signal contact with the Safety Extra-Low Voltages (SELV) in compliance with IEC60950-1/EN60950-1.



ATTENTION

This unit is a built-in type. When the unit is installed in another piece of equipment, the equipment enclosing the unit must comply with fire enclosure regulation IEC60950-1/EN60950-1 (or similar regulation).



ATTENTION

Safety First!

Be sure to disconnect the power cord before installing and/or wiring your Moxa EtherDevice Switch.

Calculate the maximum possible current in each power wire and common wire. Observe all electrical codes dictating the maximum current allowable for each wire size.

If the current goes above the maximum ratings, the wiring could overheat, causing serious damage to your equipment.

Please read and follow these guidelines:

- Use separate paths to route wiring for power and devices. If power wiring and device wiring paths must cross, make sure the wires are perpendicular at the intersection point.
NOTE: Do not run signal or communications wiring and power wiring through the same wire conduit. To avoid interference, wires with different signal characteristics should be routed separately.
- You can use the type of signal transmitted through a wire to determine which wires should be kept separate. The rule of thumb is that wiring that shares similar electrical characteristics can be bundled together.
- You should separate input wiring from output wiring.
- We advise that you label the wiring to all devices in the system.

Grounding the Moxa EDS-P510A-8PoE

Grounding and wire routing help limit the effects of noise due to electromagnetic interference (EMI). Run the ground connection from the ground screw to the grounding surface prior to connecting devices.



ATTENTION

This product is intended to be mounted to a well-grounded mounting surface such as a metal panel.

Wiring the Relay Contact

The EDS-P510A-8PoE has one relay output. The relay contact uses two contacts of the terminal block on the EDS-P510A-8PoE's top panel. Refer to the next section for detailed instructions on how to connect the wires to the terminal block connector, and how to attach the terminal block connector to the terminal block receptor.

In this section, we illustrate the meaning of the two contacts used to connect the relay contact.



FAULT:

The relay contacts of the 2-pin terminal block connector are used to detect user-configured events. The two wires attached to the fault contacts form an open circuit when a user-configured event is triggered. If a user-configured event does not occur, the fault circuit remains closed.

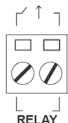

Wiring the Redundant Power Inputs

The EDS-P510A-8PoE has two sets of power inputs—power input 1 and power input 2. The two terminal block connectors on the top-left of the EDS-P510A-8PoE's top panel are used for the two power inputs. The top and front views of one of the terminal block connectors are shown here.

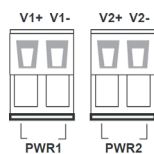

STEP 1: Insert the negative/positive DC wires into the V-/V+ terminals, respectively.

STEP 2: To keep the DC wires from pulling loose, use a small flat-blade screwdriver to tighten the wire-clamp screws on the front of the terminal block connector.

STEP 3: Insert the plastic terminal block connector prongs into the terminal block receptor, which is located on the EDS-P510A-8PoE's top panel.

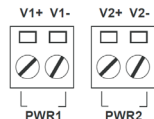

Wiring the Digital Inputs

The EDS-P510A-8PoE has one digital input. The DI consists of two contacts on the terminal block connector on the EDS-P510A-8PoE's top-right panel. The top and front views of one of the terminal block connectors are shown here.



STEP 1: Insert the negative (ground)/positive DI wires into the \ominus /I terminals, respectively.

STEP 2: To keep the DI wires from pulling loose, use a small flat-blade screwdriver to tighten the wire-clamp screws on the front of the terminal block connector.



STEP 3: Insert the plastic terminal block connector prongs into the terminal block receptor, which is located on the EDS-P510A-8PoE's top panel.

Turbo Ring DIP Switch Settings

EDS-P510A-8PoE series switches are plug-and-play managed redundant Ethernet switches. The proprietary Turbo Ring protocol was developed by Moxa to provide better network reliability and faster recovery time. Moxa Turbo Ring's recovery time is less than 300 ms (**Turbo Ring**) or 20 ms (**Turbo Ring V2**)—compared to a 3- to 5-minute recovery time for commercial switches—decreasing the possible loss caused by network failures in an industrial setting.

There are 4 Hardware DIP Switches for Turbo Ring on the top panel of EDS-P510A-8PoE that can help set up the Turbo Ring easily within seconds. If you do not want to use a hardware DIP switch to setup the Turbo Ring, you can use a web browser, telnet, or console to disable this function.

NOTE Please refer to the **Turbo Ring DIP Switch** section and **Using Communication Redundancy** section in User's Manual for more detail information about the settings and usage of **Turbo Ring** and **Turbo Ring V2**.

EDS-P510A-8PoE Series DIP Switches

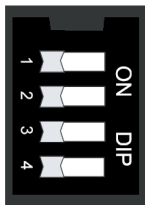

MASTER
COUPLER
TURBO
RING

The default setting for each DIP Switch is OFF. The following table explains the effect of setting the DIP Switch to the ON position.

“Turbo Ring” DIP Switch Settings

DIP 1	DIP 2	DIP 3	DIP 4
Reserved for future use.	ON: Enables this EDS as the Ring Master.	ON: Enables the default “Ring Coupling” ports.	ON: Activates DIP switches 1, 2, 3 to configure “Turbo Ring” settings.
	OFF: This EDS will not be the Ring Master.	OFF: Do not use this EDS as the ring coupler.	OFF: DIP switches 1, 2, 3 will be disabled.

“Turbo Ring V2” DIP Switch Settings

DIP 1	DIP 2	DIP 3	DIP 4
ON: Enables the default “Ring Coupling (backup)” port.	ON: Enables this EDS as the Ring Master.	ON: Enables the default “Ring Coupling” port.	ON: Activates DIP switches 1, 2, 3 to configure “Turbo Ring V2” settings.
OFF: Enables the default “Ring Coupling (primary)” port.	OFF: This EDS will not be the Ring Master.	OFF: Do not use this EDS as a ring coupler.	OFF: DIP switches 1, 2, 3 will be disabled.

NOTE You must enable the Turbo Ring function first before using the DIP switch to activate the Master and Coupler functions.

NOTE If you do not enable any of the EDS-P510A-8PoE switches to be the Ring Master, the Turbo Ring protocol will automatically choose the EDS-P510A-8PoE with the smallest MAC address range to be the Ring Master. If you accidentally enable more than one EDS-P510A-8PoE to be the Ring Master, these EDS-P510A-8PoE switches will auto-negotiate to determine which one will be the Ring Master.

LED Indicators

The front panel of the Moxa EDS-P510A-8PoE contains several LED indicators. The function of each LED is described in the following table:

LED	Color	State	Description
PWR1	AMBER	On	Power is being supplied to power input P1.
		Off	Power is not being supplied to power input P1.
PWR2	AMBER	On	Power is being supplied to power input P2.
		Off	Power is not being supplied to power input P2.
FAULT	RED	On	When a user-configured event is triggered.
		Off	When a user-configured event is not triggered.

LED	Color	State	Description	
MSTR/ HEAD	GREEN	On	When the switch is set as the Master of the Turbo Ring, or as the Head of the Turbo Chain.	
		Blinking	The switch has become the Ring Master of the Turbo Ring, or the Head of the Turbo Chain, after the Turbo Ring or the Turbo Chain is down.	
		Off	When the switch is not the Master of this Turbo Ring or is set as the Member of the Turbo Chain.	
CPLR/TAIL	GREEN	On	When the EDS-P510A-8PoE coupling function is enabled to form a back-up path, or when it's set as the Tail of the Turbo Chain.	
		Blinking	When the Turbo Chain is down.	
		Off	When the switch disables the coupling function.	
Port 1 to Port 8 (10M)	AMBER	On	TP port's 10 Mbps link is active.	
		Blinking	Data is being transmitted at 10 Mbps.	
		Off	TP port's 10 Mbps link is inactive.	
Port 1 to Port 8 (100M)	GREEN	On	TP port's 100 Mbps link is active.	
		Blinking	Data is being transmitted at 100 Mbps.	
		Off	TP port's 100 Mbps link is inactive.	
G1 to G2 (10/100/ 1000M)	AMBER	On	G1 to G2 port's 10/100Mbps link is active.	
		Blinking	Data is being transmitted at 10/100Mbps.	
		Off	G1 to G2 port's 10/100Mbps link is inactive.	
G1 to G2 (1000M)	GREEN	On	G1 to G2 port's 1000 Mbps link is active.	
		Blinking	Data is being transmitted at 1000 Mbps.	
		Off	G1 to G2 port's 1000 Mbps link is inactive.	
PoE+	AMBER	On	PoE port is connected to PoE device, using the 802.3af standard	
		Off	No PoE power output	
	GREEN	On	PoE port is connected to PoE device, using the 802.3at standard	
		Off	No PoE power output	
	RED	On	On	PoE power failure: <ul style="list-style-type: none"> Once/second: PoE detection failure Twice/second: short-circuit, overloading, or over temperature
			Off	-
		Off	-	

Specifications of EDS-P510A-8PoE Series

Technology	
Standards	IEEE 802.3af/at for Power-over-Ethernet, IEEE 802.3 for 10BaseT, IEEE 802.3u for 100BaseT(X) and 100Base FX, IEEE 802.3ab for 1000BaseT(X), IEEE 802.3z for 1000BaseSX/LX/LHX/ZX, IEEE 802.3x for Flow Control, IEEE 802.1D for Spanning Tree Protocol, IEEE 802.1w for Rapid STP, IEEE 802.1Q for VLAN Tagging, IEEE 802.1p for Class of Service, IEEE 802.1X for Authentication, IEEE 802.3ad for Port Trunk with LACP
Protocols	IGMPv1/v2, GVRP, SNMPv1/v2c/v3, DHCP Server/Client, BootP, TFTP, SNTF, SMTP, RARP, GMRP, LACP, RMON, HTTP, HTTPS, Telnet, Syslog, DHCP Option 66/67/82, SSH, SNMP Inform, Modbus/TCP, EtherNet/IP, LLDP, IEEE 1588 PTP, IPv6
MIB	MIB-II, Ethernet-Like MIB, P-BRIDGE MIB, Q-BRIDGE MIB, Bridge MIB, RSTP MIB, RMON MIB Group 1, 2, 3, 9
Flow Control	IEEE 802.3x flow control, back pressure flow control
Switch Properties	
Priority Queues	4
Max. Number of Available VLANs	64
VLAN ID Range	VID 1 to 4094
IGMP Groups	256
Interface	
RJ45 Ports	10/100BaseT(X) or 10/100/1000BaseT(X) auto negotiation speed
Fiber Ports	100/1000BaseSFP slot
Console Port	RS-232 (RJ45)
LED Indicators	PWR1, PWR2, FAULT, 10/100M (TP port), G1/G2 (Gigabit port), MSTR/HEAD, CPLR/TAIL, PoE+
DIP Switch	Turbo Ring, Master, Coupler, Reserve
Alarm Contact	Two relay outputs with current carrying capacity of 0.5A @ 48 VDC
Digital Input	Two inputs with the same ground, but electrically isolated from the electronics <ul style="list-style-type: none"> • For state "1": +13 to +30V • For state "0": -30 to +3V • Max. input current: 8 mA
PoE	
Total Power Budget	240 W
PoE Output Voltage	46.6 VDC @ 48 VDC power input
PoE Output Power	15.4 W in 802.3af, 30 W in 802.3at, 36 W in high power mode
PoE Output Current	350 mA in 802.3af, 600 mA in 802.3at, 720 mA in high power mode

Overload Current Protection at Port	Present
PoE Pinout	Mode A: Pair 1,2 (V+) ; Pair 3,6 (V-)
Power	
Rated Voltage	48 VDC, redundant dual inputs
Operating Voltage	44 to 57 VDC
Rated Current	5.36 A @ 48 VDC
Power Consumption	Max. 17.28 W without PDs' consumption
Inrush Current	1.1 A @ 48 VDC
Electrical Isolation	2250 VDC to chassis for 60 s
Heat Dissipation	52.4 BTU/h
Overload Current Protection at Input	Present
Reverse Polarity Protection	Present
Connection	2 removable 2-contact terminal blocks
Physical Characteristics	
Casing	IP30 protection, metal case
Dimensions	80.2 × 135 × 105 mm (3.16 × 5.31 × 4.13 in)
Weight	1030 g
Installation	DIN-Rail, Wall Mounting Kit (optional kit)
Environment	
Operating Temperature	0 to 60°C (32 to 140°F), standard models -40 to 75°C (-40 to 167°F) for T. models
Storage Temperature	-40 to 85°C (-40 to 185°F)
Ambient Relative Humidity	5 to 95% (non-condensing)
Altitude	Up to 2000 M (higher altitude available on demand)
Regulatory Approvals	
Safety	UL508
Traffic Control	NEMA TS2
Railway	EN 50121-4
EMI	FCC Part 15, CISPR (EN55022) class A
EMS	EN61000-4-2 (ESD), Level 3 EN61000-4-3 (RS), Level 3 EN61000-4-4 (EFT), Level 3 EN61000-4-5 (Surge), Level 3 EN61000-4-6 (CS), Level 3 EN61000-4-8 EN61000-4-11
Shock	IEC60068-2-27
Freefall	IEC60068-2-32
Vibration	IEC60068-2-6
Warranty	
Time Period	5 years
Details	www.moxa.com/warranty