

NPort 5200 Series Quick Installation Guide

Edition 8.2, November 2018

Technical Support Contact Information **www.moxa.com/support**

Moxa Americas:

Toll-free: 1-888-669-2872

Tel: 1-714-528-6777

Fax: 1-714-528-6778

Moxa China (Shanghai office):

Toll-free: 800-820-5036

Tel: +86-21-5258-9955

Fax: +86-21-5258-5505

Moxa Europe:

Tel: +49-89-3 70 03 99-0

Fax: +49-89-3 70 03 99-99

Moxa Asia-Pacific:

Tel: +886-2-8919-1230

Fax: +886-2-8919-1231

Moxa India:

Tel: +91-80-4172-9088

Fax: +91-80-4132-1045



© 2018 Moxa Inc. All rights reserved.

P/N: 1802052000313



Overview

The NPort 5200 compact palm-sized device servers are used to control RS-232 (NPort 5210/5230/5210-T/5230-T) or RS-422/485 (NPort 5230/5232/5232I/5230-T/5232-T/5232I-T) serial devices over a TCP/IP-based Ethernet.

NOTE "-T" indicates an extended operating temperature model.

Package Checklist

Before installing your NPort 5200, verify that the package contains the following items:

- 1 NPort 5200 2-port Serial Device Server
- Quick Installation Guide (printed)
- Warranty card

Optional Accessories

- DK-35A: DIN-Rail Mounting Kit (35 mm)
- CBL-RJ45M9-150: RJ45 (8-pin) to DB9 (M) cable, 150 cm
- CBL-RJ45F9-150: RJ45 (8-pin) to DB9 (F) cable, 150 cm
- CBL-RJ45M25-150: RJ45 (8-pin) to DB25 (M) cable, 150 cm
- CBL-RJ45F25-150: RJ45 (8-pin) to DB25 (F) cable, 150 cm
- DIN-Rail Power Supply and Adapter

Note: Notify your sales representative if any of the above items are missing or damaged.

Hardware Introduction

The NPort 5200 device servers are used to control RS-232/422/485 devices. The NPort 5210/5210-T has two 8-pin RJ45 ports, both for the RS-232 interface. The NPort 5230/5230-T has one 10-pin terminal block, with 5 pins used for one RS-232 port, and 5 pins used for one RS-422/485 port. The NPort 5232/5232I/5232-T/5232I-T have one 10-pin terminal block, with 5 pins used for one RS-422/485 port, and 5 pins used for another RS-422/485 port.

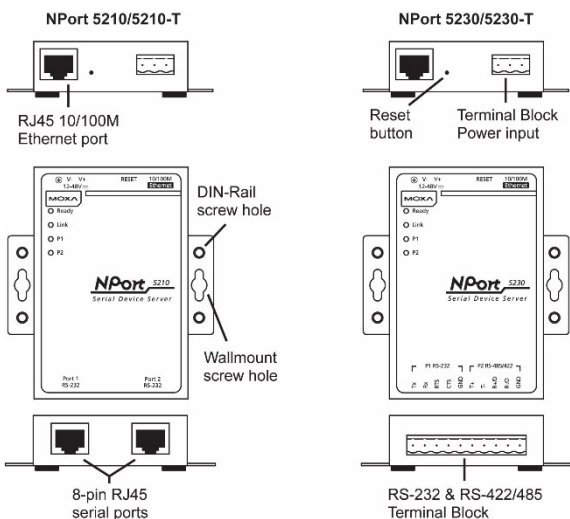

NPort 5232/5232-T

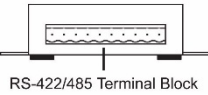
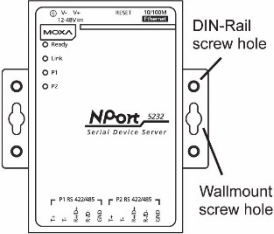
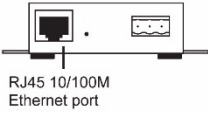

NPort 5232I/5232I-T

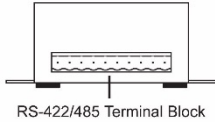
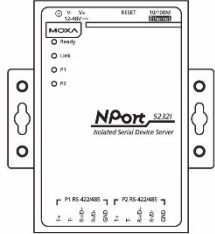
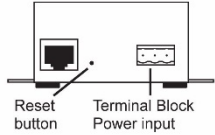

Reset Button—Press the *Reset button* continuously for 5 sec to load factory defaults: Use a pointed object, such as a straightened paper clip or toothpick, to press the reset button. This will cause the Ready LED to blink on and off. The factory defaults will be loaded once the Ready LED stops blinking (after about 5 seconds). At this point, you should release the reset button.

NPort 5200 LED Indicators (top panel)

LED Name	LED Color	LED Function
Ready	Red	Steady on: Power is on and the NPort 5200 is booting up.
		Blinking: Indicates an IP conflict, or DHCP or BOOTP server did not respond properly.
	Green	Steady on: Power is on and the NPort 5200 is functioning normally.
		Blinking: The device server has been located by Administrator's Location function
	Off	Power is off, or power error condition exists.
Ethernet	Orange	10 Mbps Ethernet connection.
	Green	100 Mbps Ethernet connection.
	Off	Ethernet cable is disconnected, or has a short.
P1, P2	Orange	Serial port is receiving data.
	Green	Serial port is transmitting data.
	Off	No data is being transmitted or received through the serial port.

Hardware Installation Procedure

STEP 1: After removing the NPort 5200 from the box, the first thing you should do is connect the power adapter. Connect the 12-30 VDC power line with the NPort 5200's terminal block, or connect the DIN-rail power supply with the NPort 5200's terminal block.

STEP 2: Connect the NPort 5200 to a network. Use a standard straight-through Ethernet cable to connect to a hub or switch. When setting up or testing the NPort 5200, you might find it convenient to connect directly to your computer's Ethernet port. In this case, use a cross-over Ethernet cable.

STEP 3: Connect the NPort 5200's serial port to a serial device.

STEP 4: Placement Options

In addition to placing the NPort 5200 on a desktop or other horizontal surface, you may also make use of the DIN-rail or wall mount options, as illustrated here.

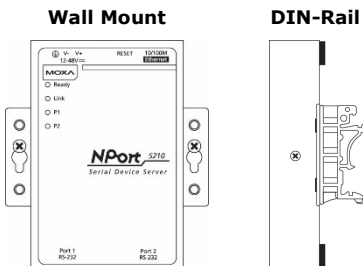

Software Installation Information

For the NPort's configuration, the default IP address of the NPort is: LAN: Static IP = 192.168.127.254; netmask = 255.255.255.0

You may log in with the password **moxa** to change any settings to meet your network topology (e.g., IP address) or serial device (e.g., serial parameters). If you would like to apply the Real COM mode to your application, you will need to install the NPort's driver on your desktop. You may also refer to Moxa's support website <https://www.moxa.com/support/> for the user's manual, driver, NPort Search Utility, and more.

NOTE For the NPort with RJ45 serial ports, you may refer to the RJ45 Ports pin assignment section to loop back pin 4 and pin 5 for the RS-232 interface to carry out a self test on the device.

Pin Assignments and Cable Wiring— NPort 5230/5230-T

Terminal Block Wiring

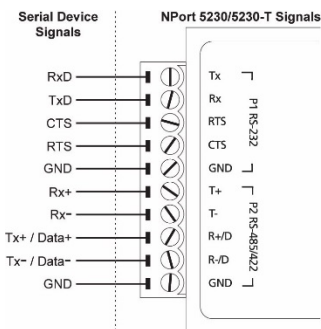

NOTE The NPort 5232/5232I/5232-T/5232I-T have 2 RS-422/485 ports. The pin assignments are the same as the NPort 5230/5230-T's port 2. Refer to the "NPort 5200 Series User's Manual" for more details.

Pin Assignments and Cable Wiring— NPort 5210/5210-T

RJ45 (8-pin) Connector Pinouts

8-Pin	Signal
1	DSR
2	RTS
3	GND
4	TxD
5	RxD
6	DCD
7	CTS
8	DTR

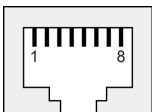

Cable Wiring (RS-232)

Four cables are available as optional accessories to connect the NPort 5210/5210-T to RS-232 serial devices. For your convenience, we show precise cable wiring diagrams for each of the four cables.

RJ45 (8-pin) to DB25 Female (Cable Name: CBL-RJ45F25-150)

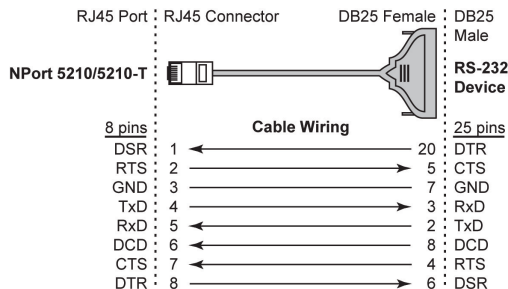

RJ45 (8-pin) to DB25 Male (Cable Name: CBL-RJ45M25-150)

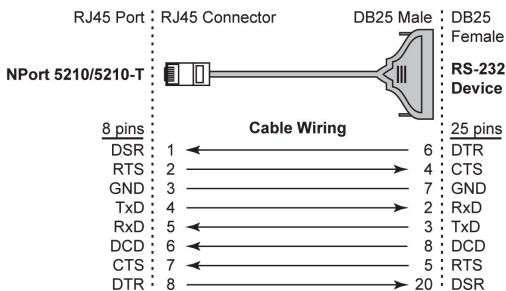

RJ45 (8-pin) to DB9 Female (Cable Name: CBL-RJ45F9-150)

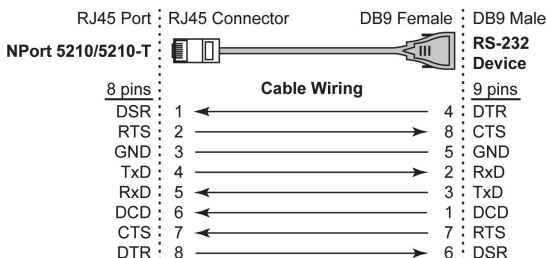

RJ45 (8-pin) to DB9 Male (Cable Name: CBL-RJ45M9-150)

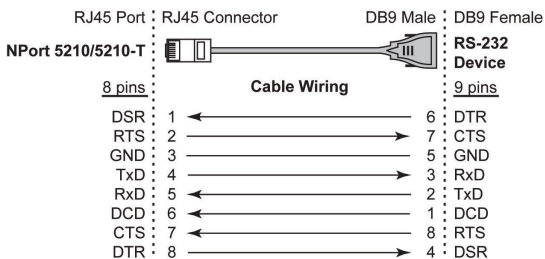

Specifications

Power Requirements

NPort 5210/5210-T: 12 to 48 VDC, 325 mA at 12V (max.)

NPort 5230/5230-T: 12 to 48 VDC, 325 mA at 12V (max.)

NPort 5232/5232-T: 12 to 48 VDC, 280 mA at 12V (max.)

NPort 5232I/5232I-T: 12 to 48 VDC, 365 mA at 12V (max.)

Operating Temp.

Standard models: 0 to 55°C (32 to 131°F)

T models: -40 to 75°C (-40 to 167°F)

Operating humidity: 5 to 95% RH

Dimensions

NPort 5210/5230/5232/5210-T/5230-T/5232-T (including ears):

90 × 100.4 × 22 mm (3.54 × 3.95 × 0.87 in)

NPort 5210/5230/5232/5210-T/5230-T/5232-T (without ears):

67 × 100.4 × 22 mm (2.64 × 3.95 × 0.87 in)

NPort 5232I/5232I-T (including ears):

90 × 100.4 × 35 mm (3.54 × 3.95 × 1.37 in)

NPort 5232I/5232I-T (without ears):
67 × 100.4 × 35 mm (2.64 × 3.95 × 1.37 in)

Regulatory Approvals

Safety	UL 60950-1
EMC	EN 55032/24
EMI	CISPR 32, FCC Part 15B Class A
EMS	IEC 61000-4-2 ESD: Contact: 4 kV; Air: 8 kV IEC 61000-4-3 RS: 80 MHz to 1 GHz: 3 V/m IEC 61000-4-4 EFT: Power: 1 kV; Signal: 0.5 kV IEC 61000-4-5 Surge: Power: 1 kV IEC 61000-4-6 CS: 150 kHz to 80 MHz: 3 V/m; Signal: 3 V/m IEC 61000-4-8 PFMF IEC 61000-4-11 DIPs
Marine	DNV (excluding the NPort 5210)
Medical	(NPort 5210 only) EN 60601-1-2 Class B, EN55011